



**FOR PROFESSIONALS**



**MÜNCHMEYER**  
**»STERNKREUZ«**  
GmbH & Co. KG

**Mineralgläser**

Rund, flach und gewölbt	2-3
Sonderformen	4-11
Imitationen aus Kunststoff	12
Platten	13
Formgläser	14-16

**Saphirgläser**

Rund, flach und gewölbt	17
-------------------------	----

**Kunststoffgläser**

Einsprenggläser	18-21
Stülpgläser	22-26
Armierte Gläser	27-37
Kapselgläser	37
Unterleggläser	38
Formproofgläser	39
Platten	40
Formgläser	41-59

**Dichtungen**

I, L, O u. Flachdichtungen	60-61
----------------------------	-------

**Wecker- u. Großuhrgläser**

Mineral u. Kunststoff	62
-----------------------	----

**Marken- u. Kaliberschlüssel**

Alphabetisch nach Marke geordnet	63-71
----------------------------------	-------

**Handwerkszeug**

Maschinen und Zubehör	72-80
-----------------------	-------

**Mineral Glasses**

Round, flat and domed	2-3
Special Forms	4-11
Imitations	12
Sheets	13
Fancy Glasses	14-16

**Sapphire Glasses**

Round, flat and domed	17
-----------------------	----

**Plastic Glasses**

Snap-in glasses	18-21
Top glasses	22-26
Armed glasses	27-37
Capsules	37
Underlayered glasses	38
Formproof glasses	39
Sheets	40
Fancy glasses	41-59

**Gaskets**

I, L, O and flat gaskets	60-61
--------------------------	-------

**Clock Glasses**

Mineral and Plastic	62
---------------------	----

**Key to Brands and Calibres**

alphabetically listed according to brands	63-71
---	-------

**Tools**

Machines and accessories	72-80
--------------------------	-------

# Rund Mineral – Round Mineral



**MS**

1,0 – 1,1 mm dick/thick

○ MS 130 – MS 460

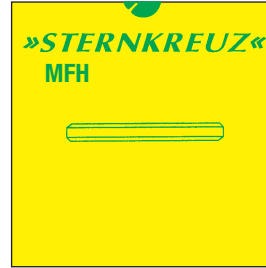

**MFH**

2,0 mm dick/thick

○ MFH 165 – MFH 380  
MFH 155, 160  
385, 390



**MST**

0,7 – 0,8 mm dick/thick

○ MST 120 – MST 340



**MF**

1,8 – 1,9 mm dick/thick

○ MF 176 – MF 371



**MSI**

1,0 – 1,1 mm dick/thick

○ MSI 140 – MSI 340



**MSH**

2,5 mm dick/thick

○ MSH 175 - MSH 340



**MFO**

1,1 – 1,2 mm dick/thick

○ MFO 170 – MFO 351

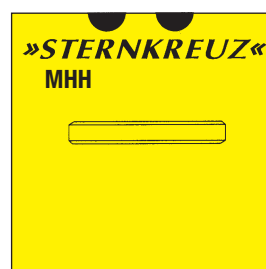

**MHH**

3,0 mm dick/thick

○ MHH 250 – MHH 335



**MSM**

1,4 – 1,5 mm dick/thick

○ MSM 180 – MSM 340



**ML**

ML 4,5 X 3,6  
ML 5,9 X 4,7  
ML 7,5 X 6,3

○ Alle Nummern lieferbar / all Numbers available

# Rund Mineral – Round Mineral



**MDT** 0,7 – 0,9 mm dick/thick  
○ MDT 140 – MDT 340



**MDM** 1,1 – 1,2 mm dick/thick  
○ MDM 180 – MDM 380  
+ 385, 390, 395, 400



**MDH** 2,0 mm dick/thick  
○ MDH 240 - MDH 330



**MD** 2,0 mm dick/thick  
MD 270, MD 275,  
280 ...  
MD 315, 320.

○ Alle Nummern lieferbar / all Numbers available

STERNKREUZ-Mineralgläser und STERNKREUZ-Mineralglasplatten sind - mit Ausnahme der Großuhrgläser MMG - gegen Bruch chemisch gehärtet. Diese Eigenschaft kann man den Gläsern nicht ansehen. Sie ist aber für die problemlose Verarbeitung außerordentlich wichtig. Durch einen in der Herstellung genau überwachten Ionenaustausch sind die Gläser hoch gespannt. Sie können dadurch einen starken Schlag mit Durchbiegung vertragen und die Platten können auf den Kopiermaschinen, wie KRONOGLAS, gut bearbeitet werden.

Achten Sie daher bitte immer auf das Markenzeichen STERNKREUZ.

STERNKREUZ-mineral glasses and STERNKREUZ-mineral glass plates are - with the exception of the glasses for alarm clocks MMG - chemically tempered against breakage. This property cannot be seen when looking at these glasses. However, it is very important for the manufacture without any problems. Due to ionic exchange which is well controlled during the manufacture, the glasses are highly stressed. Therefore they are shock-resistant and the plates can be processed wet on the copying machines, i. e. KRONOGLAS.

Therefore we ask you always to pay regard to the trade mark STERNKREUZ.

# Rund Sonderformen Mineral

## Round Special Forms Mineral



**XMF** Sonderformglas  
flach  
Special form glass  
flat

XMF 160.866

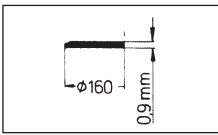

Aristo 1121

XMF 170.856

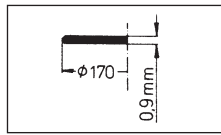

Seiko 170 N02GN

XMF 175.867

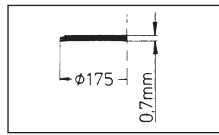

Aristo 16700

XMF 180.852

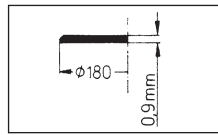

Seiko 180 N10 GN

XMF 185.823

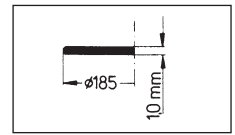

Dugena 991051, 991061

XMF 187.815

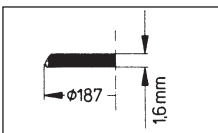

Dugena E 5106-418

XMF 190.845

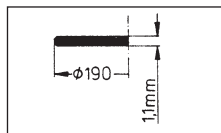

Seiko 190 W 35HN00

XMF190.854

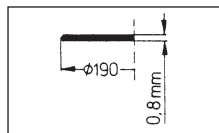

Seiko 190N20GN

XMF 190.926

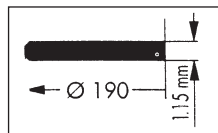

Seiko 190P01 HN03

XMF 193.922

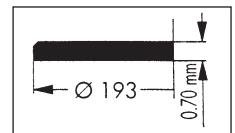

Citizen 54-31293E

XMF 200.851

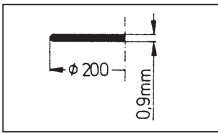

Seiko 200N37KN00

XMF 200.864

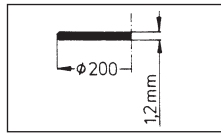

Seiko 200 W49LN00

XMF 202.890

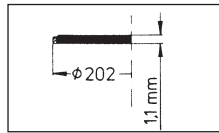

Citizen 54-71720

XMF 204.880

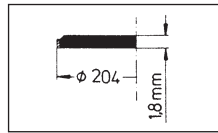

Citizen 54-50940

XMF 204.882

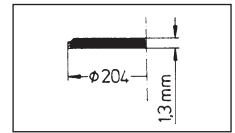

Citizen 54-56730S

XMF 206.887

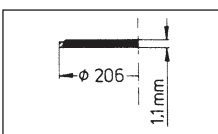

Citizen 54-71140

XMF 227.816

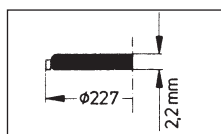

Dugena E 4115.318

XMF 255.868

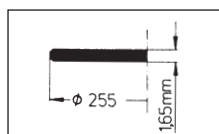

Porsche Orfina Unisex

XMF 262.836

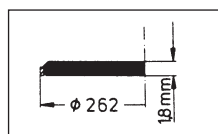

Casio 31QR-17

XMF 265.874

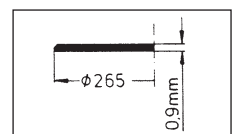

Seiko 265 N06 GN00

XMF 270.837

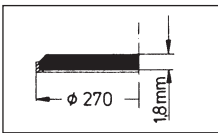

Casio R15

XMF 271.812

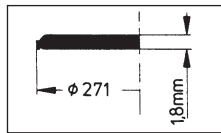

Casio R 1613

XMF 275.840

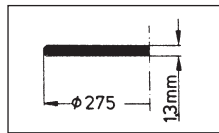

Orient 16-2451

XMF 276.893

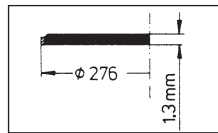

Citizen 54-7750

XMF 277.830

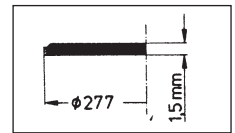

Citizen 54-50480

XMF 280.872

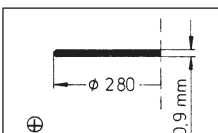

Seiko 280 N25 KN00

XMF 281.895

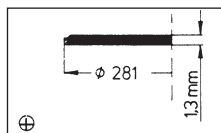

Citizen 54-90705 F

XMF283.838

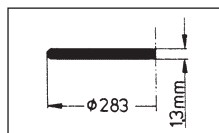

Orient 16-1838

XMF 283.923

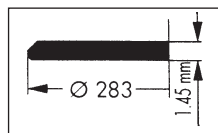

Citizen 54-51650

XMF285.841



Orient 16-1031

# Rund Sonderformen Mineral

## Round Special Forms Mineral



XMF 285.875

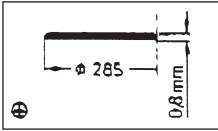

Seiko 285 N05 KN 00

XMF 285.876

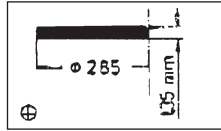

Seiko 285W6I LN00

XMF 285.877

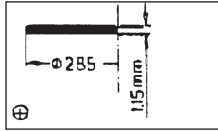

Seiko 285 W12 GN00

XMF 287.829

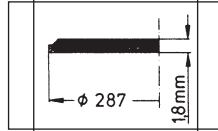

Citizen 54-5T060

XMF 290.861

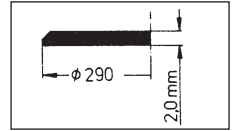

Seiko 290W08 GN

XMF 290.873

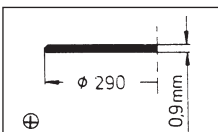

Seiko 290 N06 GN00

XMF 292.894

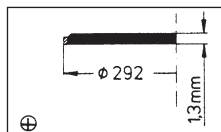

Citizen 54-77650

XMF 292.896

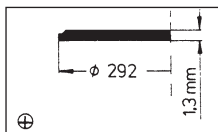

Citizen 54-92610

XMF 295.839

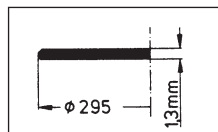

Orient 16-1620

XMF 295.846

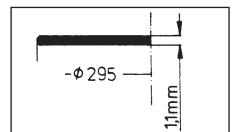

Seiko 295W35 HN00

XMF 295.849

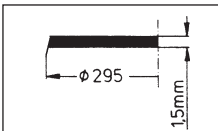

Seiko 295W16 GA

XMF 295.850

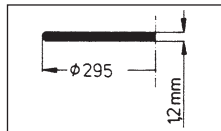

Seiko 295W41 LN00

XMF 295.858

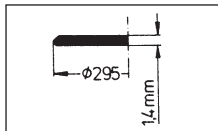

Seiko 295W29 LN00

XMF 295.859

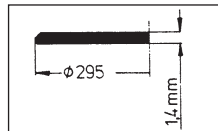

Seiko 295W29 HN00

XMF 295.869

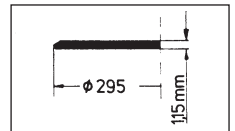

Ricoh PW 749-2

XMF 295.871

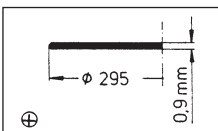

Seiko 295 N15 KN00

XMF 297.888

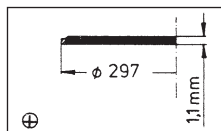

Citizen 54-71250

XMF 298.802

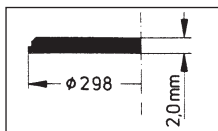

Orient 5096.M104 GC

XMF 298.820

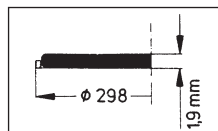

Dugena I 4569.718

XMF 298.842

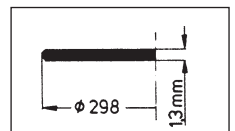

Orient 16-2332

XMF 299.886

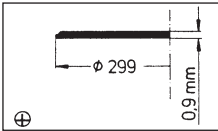

Citizen 54-70460

XMF 300.860

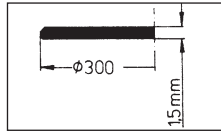

Seiko 300 W 08 GN

XMF 300.862

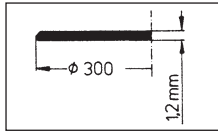

Seiko 300 W 76 GN

XMF 300.863

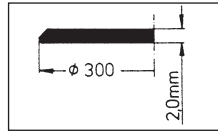

Seiko 300 W96 GN

XMF 300.865

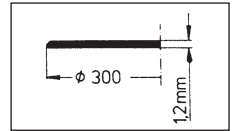

Ricoh 580508

XMF 302.881

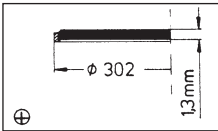

Citizen 54-56560

XMF 302.892

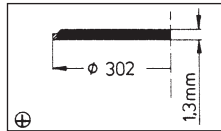

Citizen 54-77030 S

XMF 303.827

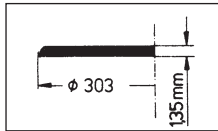

Zentra

XMF 304.817

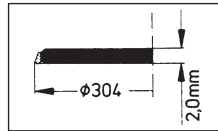

Dugena A1127.414

XMF 306.889

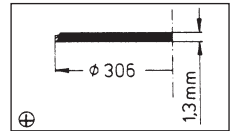

Citizen 54-71260

XMF 307.828

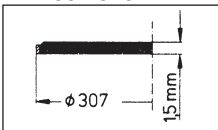

Citizen 54-40520

XMF 307.878

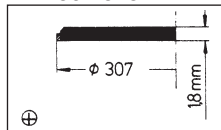

Citizen 54-50440

XMF 307.879

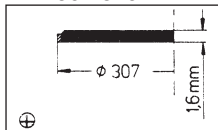

Citizen 54-50520

XMF 307.883

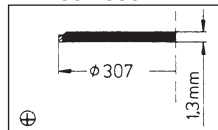

Citizen 54-56770

XMF 307.884

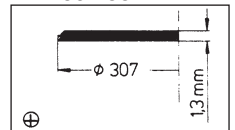

Citizen 54-70200

# Rund Sonderformen Mineral Round Special Forms Mineral

XMF 307.885

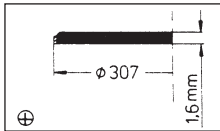

Citizen 54-70260

XMF 307.891

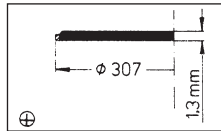

Citizen 54-77000

XMF 310.847

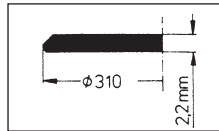

Seiko 310 W19 GN00

XMF 310.848

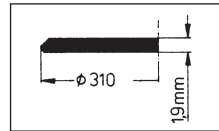

Seiko 310 W17 GN00

XMF 310.853

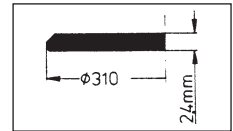

Seiko 310 W 50 GN

XMF 310.857

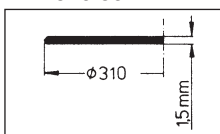

Seiko 310 W21 GN00

XMF 310.925

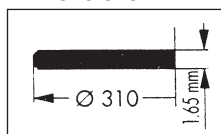

Seiko 310 W62 GN00 1209

XMF 315.818

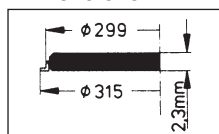

Dugena I 4640.718

XMF 318.924

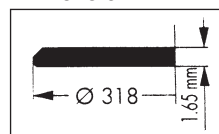

Citizen 54-63141

XMF 320.855

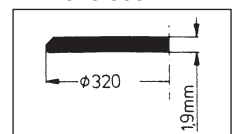

Seiko 320 W19 GN00

XMF 320.927

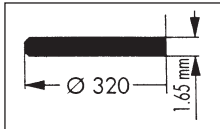

Seiko 320 W42 GN001148

XMF 322.870

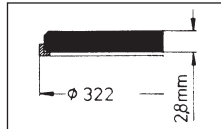

Herma

XMF 330.928

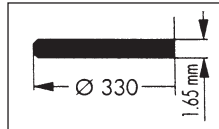

Seiko 330 W26 GN00HL

XMF 360.822

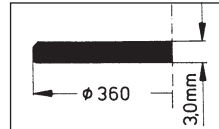

Orient 16-622

XMF 365.900

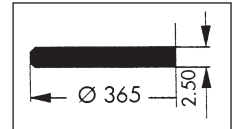

Seiko 365 V06 GNSO

XMF 370.803

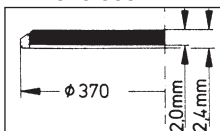

Orfina Porsche Design

XMF 373.804

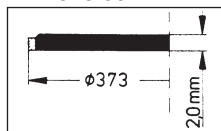

Orfina Porsche Design

# Rund Sonderformen Mineral Optik Round Special Forms Mineral Optic



XMF/O 180.703

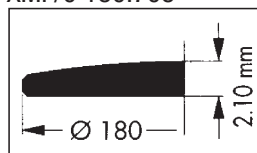

Bezeichnung designation	Durchmesser/mm diameter/mm	Höhe/Mitte/mm height/centre/mm	Höhe/Rand/mm height/rim/mm
XMF/O 155.725	15,5	2,1	1,6
XMF/O 180.703	18,0	2,1	1,45
XMF/O 185.726	18,5	2,3	1,6
XMF/O 190.729	19,0	2,45	1,2
XMF/O 195.730	19,5	2,45	1,2
XMF/O 200.716	20,0	2,45	1,0
XMF/O 205.731	20,5	3,0	1,2
XMF/O 210.727	21,0	2,45	1,6
XMF/O 210.735	21,0	4,4	2,1
XMF/O 215.734	21,5	2,1	1,5
XMF/O 220.728	22,0	2,45	1,6
XMF/O 250.732	25,0	2,45	1,2
XMF/O 256.714	25,6	2,45	1,2
XMF/O 260.736	26,0	3,2	2,0
XMF/O 264.713	26,4	2,45	1,2
XMF/O 265.737	26,5	3,2	1,3
XMF/O 266.715	26,6	2,45	1,2
XMF/O 268.742	26,8	3,2	1,6
XMF/O 270.700	27,0	2,45	1,2
XMF/O 273.743	27,3	3,2	1,6
XMF/O 275.701	27,5	2,4	1,3
XMF/O 278.744	27,8	3,2	1,6
XMF/O 280.705	28,0	2,45	1,2
XMF/O 283.745	28,3	3,2	1,6
XMF/O 285.706	28,5	2,45	1,2
XMF/O 288.746	28,8	3,2	1,6
XMF/O 290.605	29,0	4,4	3,5
XMF/O 290.707	29,0	2,45	1,2
XMF/O 290.723	29,0	4,4	2,0
XMF/O 293.747	29,3	3,2	1,6
XMF/O 295.708	29,5	2,45	1,2
XFM/O 296.738	29,6	3,2	2,0
XMF/O 298.712	29,8	2,45	1,2
XMF/O 298.721	29,8	4,0	2,75
XMF/O 299.613	29,9	5,5	3,5
XMF/O 300.709	30,0	2,45	1,2
XMF/O 303.748	30,3	3,2	1,6
XMF/O 305.710	30,5	2,45	1,2
XMF/O 308.749	30,8	3,2	1,6



# Rund Sonderformen Mineral Optik Round Special Forms Mineral Optic



Bezeichnung designation	Durchmesser/mm diameter/mm	Höhe/Mitte/mm height/centre/mm	Höhe/Rand/mm height/rim/mm
XMF/O 310.711	31,0	2,45	1,2
XMF/O 313.750	31,3	3,2	1,6
XMF/O 315.702	31,5	3,65	2,3
XMF/O 315.718	31,5	2,45	1,0
XMF/O 320.719	32,0	2,45	1,0
XMF/O 325.720	32,5	2,45	1,0
XMF/O 330.739	33,0	2,5	1,8
XMF/O 335.740	33,5	2,5	1,8
XMF/O 340.741	34,0	2,5	1,1
XMF/O 345.722	34,5	4,4	2,4
XMF/O 350.704	35,0	2,7	1,9
XMF/O 350.717	35,0	3,65	1,0
XMF/O 355.606	35,5	4,0	1,3
XMF/O 360.733	36,0	3,3	1,5
XMF/O 365.607	36,5	4,0	2,0
XMF/O 365.612	36,5	2,5	1,5
XMF/O 370.600	37,0	3,3	1,5
XMF/O 375.601	37,5	3,3	1,5
XMF/O 380.602	38,0	3,3	1,5
XMF/O 385.608	38,5	4,0	2,0
XMF/O 390.609	39,0	4,0	2,0
XMF/O 395.614	39,5	4,0	1,6
XMF/O 400.603	40,0	3,7	1,8
XMF/O 405.610	40,5	4,0	1,3
XMF/O 410.611	41,0	4,0	1,3
XMF/O 450.604	45,0	3,6	1,5

## Rund Sonderformen Mineral Dick Round Special Forms Mineral Thick



Bezeichnung designation	Durchmesser/mm diameter/mm	Stärke/mm thickness/mm
XMH 285.400	28,5	3,95
XMH 315.402	31,5	4,0
XMH 325.401	32,5	4,0

# Rund Sonderformen Mineral Round Special Forms Mineral



**XMR** Rundglas-Sonderform für Rolex  
Special form round for Rolex

XMR 199.202

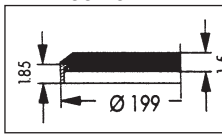

for Rolex 67-193

XMR 216.204

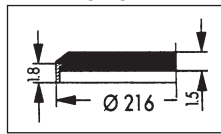

for Rolex 25-206

XMR 257.201

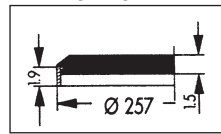

for Rolex 25-246

XMR 297.203

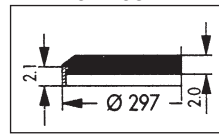

for Rolex 25-286

XMR 306.200

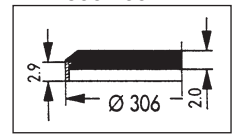

for Rolex 25-295-1



**XMR/L** Rundglas-Sonderform für Rolex mit Lupe  
Special form round for Rolex with lens

XMR / L 216.302

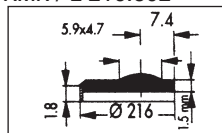

for Rolex 25-206 C

XMR / L 257.303

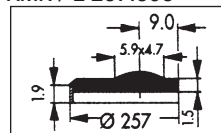

for Rolex 25-246 C

XMR / L 297.304

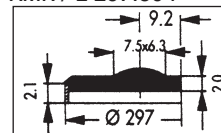

for Rolex 25-286 C

XMR / L 306.300

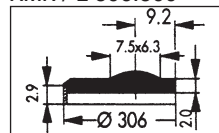

for Rolex 25-295 C1

XMR / L 306.301

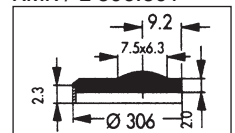

for Rolex 25-295 C2

# Rund Sonderformen Mineral Round Special Forms Mineral



XMD 295.800

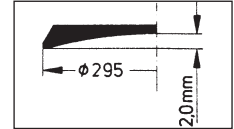

Orient OS561.OS575.OS578  
OS-589MDR,OS5086,M103GC

XMD 300.843

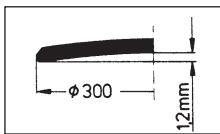

XMD 307.813

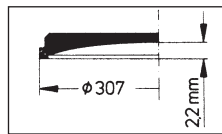

BWC 753082

XMD 308.807

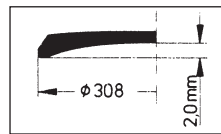

Olympic

XMD 310.814

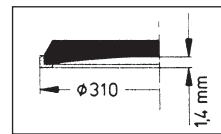

Dugena A5115.518

XMD 310.819

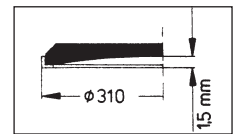

Adora 169

XMD 310.825

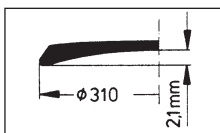

Zentra 496.152/16

XMD 310.826

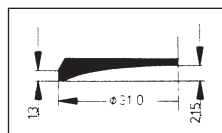

Olympic 1670-C

XMD 315.808

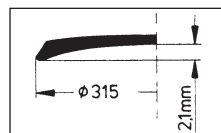

Orient OS-533m Drücker  
M 102 GC

XMD 315.809

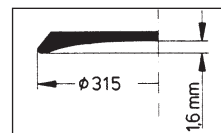

Orient OS544m Drücker  
M 102 GC

XMD 324.801

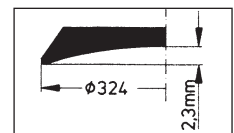

Orient OS 501m Drücker  
M101 GC

XMD 325.805

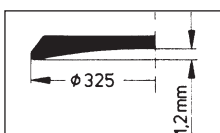

Dugena 851 145

XMD 330.821

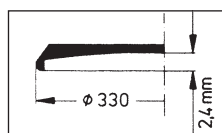

Seiko 330 W 18 GN

XMD 330.844

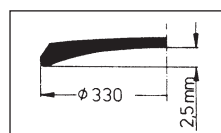

Seiko 330 W16 GN

XMD 337.829

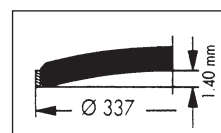

Jungh. Benetton 6001

XMD 340.811

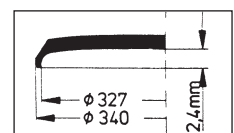























Seiko 340 W 14 GN











# Rund Sonderformen Mineral Round Special Forms Mineral



**»STERNKREUZ«**  
**XMB**  
  
MINERAL  
Special form round  
flat with border Print  
Rundglas-Sonderform  
flach mit Randdruck

 <b>XMB/B 219/162</b> schwarz, black, noir	 <b>XMB/B 260/226</b> schwarz, black, noir	 <b>XMB/BG 287/220</b> schwarz, black, noir	 <b>XMB/B 320/245</b> schwarz, black, noir
 <b>XMB/G 219/162</b> gold, gold, or	 <b>XMB/G 260/242</b> gold, gold, or	 <b>XMB/B 290/215</b> schwarz, black, noir	 <b>XMB/G 320/245</b> gold, gold, or
 <b>XMB/BG 227/172</b> schwarz, black, noir	 <b>XMB/B 260/242</b> schwarz, black, noir	 <b>XMB/B 300/229</b> schwarz, black, noir	 <b>XMB/MW 324/264</b> weiß, white, blanc
 <b>XMB/B 235/170</b> schwarz, black, noir	 <b>XMB/B 270/210</b> schwarz, black, noir	 <b>XMB/G 300/229</b> gold, gold, or	 <b>XMB/B 325/250</b> schwarz, black, noir
 <b>XMB/B 250/185</b> schwarz, black, noir	 <b>XMB/B 279/237</b> schwarz, black, noir	 <b>XMB/B 310/235</b> schwarz, black, noir	 <b>XMB/B 377/231</b> schwarz, black, noir
 <b>XMB/B 260/200</b> schwarz, black, noir	 <b>XMB/G 279/237</b> gold, gold, or	 <b>XMB/B 312/250</b> schwarz, black, noir	

**»STERNKREUZ«**  
**XMD / BB**  
  
MINERAL  
Special form round  
domed with border Print  
Rundglas-Sonderform  
gewölbt mit Randdruck

 <b>XMD/BB 220/160</b> schwarz, black, noir	 <b>XMD/BB 260/190</b> schwarz, black, noir	 <b>XMD/BB 310/240</b> schwarz, black, noir
 <b>XMD/BB 225/165</b> schwarz, black, noir	 <b>XMD/BB 280/210</b> schwarz, black, noir	 <b>XMD/BB 320/240</b> schwarz, black, noir
 <b>XMD/BB 240/180</b> schwarz, black, noir	 <b>XMD/BB 285/215</b> schwarz, black, noir	 <b>XMD/BB 330/250</b> schwarz, black, noir
 <b>XMD/BB 250/180</b> schwarz, black, noir	 <b>XMD/BB 300/230</b> schwarz, black, noir	

last Letter:  
letzter Buchstabe:  
**B** = black / schwarz  
**G** = gold / gold  
**W** = white / weiß  
**M** = minuterings /  
Minutenring

# Rund Mineral Imitation aus Kunststoff

## Round Mineral Imitation of Plastic

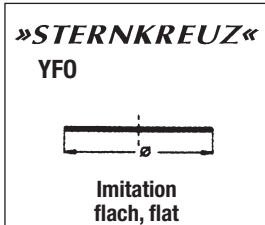

**YFO**



○ YFO 140-350

Imitation, flach, farblos, aus Kunststoff  
Imitation of plastics, flat, colourless  
1,0 – 1,2 mm dick / thick



**YBO**



□ YBO 270-350

Imitation, bombiert, farblos, aus Kunststoff  
Imitation of plastics, domed, colourless  
2,0 mm dick / thick

XY 195.206 III

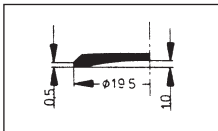

XY 301.219 III

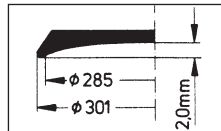

XY 308.207 III

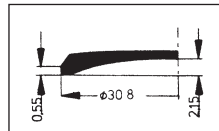

XY 310.353 III

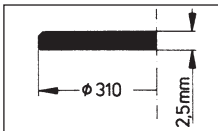

R.Pfisterer 29 K

XY 312.218 III

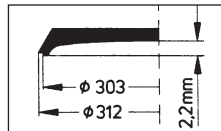

ENCAR 167 07 109

XY 317.209 III

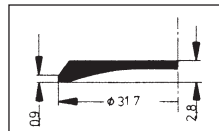

XY 320.208 III

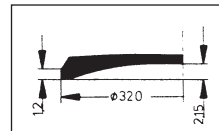

XY 320.214 III

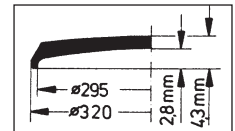

XY 324.210 III

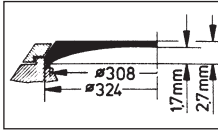

Candino

XY 325.220 III

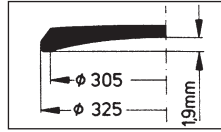

Dugena 851 145

XY 330.215 III

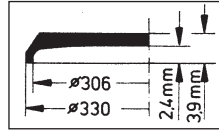

XY 340.354 II

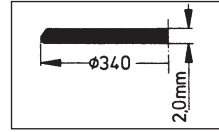

Seiko 340W18 GN

XY 340.216 III

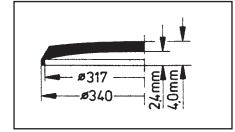

○ ALLE NUMMERN LIEFERBAR / ALL NUMBERS AVAILABLE · □ ALLE GERADEN NUMMERN LIEFERBAR / ALL EVEN NUMBERS AVAILABLE

# Platten Mineral – Sheets Mineral



Uhrglasplatten aus Mineralglas, chemisch gehärtet, zum Schleifen von Mineral-Formgläsern auf Kopierschleifmaschinen, wie z. B. KRONOGLAS.

Watch glass plates of mineral glass, chemically hardened, for grinding mineral fancy glasses on copying milling machines, e.g. KRONOGLAS.



## Runde Ausführung – Round type

MPL Ø 15 x 0,7 mm	MPL Ø 30 x 0,7 mm	MPL Ø 40 x 0,7 mm
MPL Ø 15 x 0,9 mm	MPL Ø 30 x 0,9 mm	MPL Ø 40 x 0,9 mm
MPL Ø 15 x 1,1 mm	MPL Ø 30 x 1,1 mm	MPL Ø 40 x 1,1 mm
MPL Ø 20 x 0,7 mm	MPL Ø 30 x 1,3 mm	MPL Ø 40 x 1,3 mm
MPL Ø 20 x 0,9 mm	MPL Ø 35 x 0,7 mm	MPL Ø 40 x 1,5 mm
MPL Ø 20 x 1,1 mm	MPL Ø 35 x 0,9 mm	MPL Ø 40 x 1,8 mm
MPL Ø 25 x 0,7 mm	MPL Ø 35 x 1,1 mm	MPL Ø 45 x 0,9 mm
MPL Ø 25 x 0,9 mm	MPL Ø 35 x 1,3 mm	MPL Ø 45 x 1,1 mm
MPL Ø 25 x 1,1 mm		MPL Ø 45 x 1,3 mm

## MPL / H

MPL / H 40 x 2,5 mm	MPL / H 50 x 2,5 mm	MPL / H 55 x 2,0 mm
MPL / H 40 x 3,0 mm		

## Quadratische Ausführung – Square type

MPL 15 x 15 x 0,7 mm	MPL 25 x 25 x 0,7 mm	MPL 35 x 35 x 0,7 mm	MPL 40 x 40 x 0,9 mm
MPL 15 x 15 x 0,9 mm	MPL 25 x 25 x 0,9 mm	MPL 35 x 35 x 0,9 mm	MPL 40 x 40 x 1,1 mm
MPL 15 x 15 x 1,1 mm	MPL 25 x 25 x 1,1 mm	MPL 35 x 35 x 1,1 mm	MPL 40 x 40 x 1,3 mm
MPL 20 x 20 x 0,7 mm	MPL 25 x 25 x 1,3 mm	MPL 35 x 35 x 1,3 mm	
MPL 20 x 20 x 0,9 mm	MPL 30 x 30 x 0,7 mm	MPL 35 x 35 x 1,5 mm	
MPL 20 x 20 x 1,1 mm	MPL 30 x 30 x 0,9 mm	MPL 35 x 35 x 1,8 mm	
	MPL 30 x 30 x 1,1 mm		
	MPL 30 x 30 x 1,3 mm		



## Mineralglas-Rohlinge gewölbt, chemisch gehärtet – Blanks of mineral glass, domed, chemically hardened

MDR Ø 22 x 0,8 mm
MDR Ø 35 x 0,9 mm
MDR Ø 36 x 2,0 mm
MDR Ø 40 x 0,9 mm
MDR Ø 40 x 3,7 mm
MDR Ø 45 x 1,2 mm
MDR Ø 50 x 1,1 mm



Maße / dimensions	verfügbare Radien / available radia
MZL 220 x 160 x 1,0	40, 50, 60, 70, 80, 100
MZG 300 x 200 x 1,0	40, 50, 60, 70, 80, 100
MZG 350 x 250 x 1,0	30, 40, 50, 60, 70, 80, 100
MZG 370 x 280 x 1,0	40, 50, 60, 70, 80, 100
MZG 430 x 320 x 0,7	60, 80, 100
MZG/B 280 x 370 x 1,0	60

# Form Mineral – Fancy Mineral



## Rechteckform / Rectangular shape

Order-Nr		Marke
MRs	122x122.1	
MRs	144x120.1	
MRr	162x141.1	Aristo 11100
MRs	166x156.1	Aristo 1101
MRz	177x143.1	
MRs	179x164.1	Orient 16-2336
MRs	180x180.1	
MRr	181x151.1	
MRs	190x170.1	Citizen
MRs	195x180.1	
Mra	197x197.1	
MRr	1 99x1 89.1	Junghans 42-197-0896
MRr	200x095.1	
MRr	202x102.1	Citizen
MR	205x105.1	
MRr	217x096.1	
MR	221x186.1	Citizen 54-31206
MRr	230x230.1	
MRs	231x221.1	Orient
MRr	235x215.1	Aristo 7160
MRr	235x220.1	Seiko ESHN59 HNOO
MRr	239x224.1	Orient 16-2160
MR	240x120.1	
MR	240x200.1	Seiko RE6N 73 LNOO
MR	245x200.1	Seiko RE 4N 22GN 00
MRr	251x221.1	
MRs	260x245.1	Seiko RW 1W81 LNO1
MRr	260x260.1	
MRs	265x235.1	Orient 16-2474
MRr	265x270.1	Junghans 1398
MRr	270x255.1	Citizen 54-21118
MRr	272x252.1	Aristo 2101
MRr	279x279.1	Junghans 42-197-0882
MRr	280x280.1	
MRs	281x269.1	Citizen 54-21117 F
MRs	289x279.1	Junghans 9.850.874
MRr	296x180.1	Kienzle 851 4900

## Tonnenform / Barrel shape

Order-Nr		Marke
MTs	151x131.1	Aristo 11370
MTs	153x136.1	Aristo 1140
MTr	154x149.1	Orient 16-2391
MTr	180x230.1	Rico 824003
MTr	188x273.1	Seiko BAOW 95 LNOO -
MTr	189x269.1	Seiko BAOW 91 LNOO
MTr	200x300.1	Orient 16-1052
MTr	209x299.1	Citizen 54-79010
MTr	219x284.1	Seiko BAO W49 LNOO
MTs	226x268.1	Dugena A860291
MTr	228x288.1	Aristo 5200
MTr	230x295.2	Citizen 54-78750
MT	230x310.1	Rico 840001
MTr	238x268.1	Citizen 54-15025 F
MTr	240x280.1	Kienzle 8529710
MTr	240x290.1	Citizen 54-75820
MT	240x298.1	Dugena 869174 150
MTr	242x270.1	Dugena 899 123.149
MTr	243x283.1	Citizen 54-16015 F
MTr	247x288.1	Aristo 5100
MTr	250x310.1	Citizen 54-76270
MTr	251x256.1	Orient 16-2380
MTr	255x235.1	Seiko ES 1W 32 GN00
MTs	256x255.1	
MTr	259x279.1	Continental
MTr	261x291.1	Rico 840004
MTr	263x308.1	Citizen 54-79830
MTr	265x255.1	Seiko
MTs	265x265.1	Citizen 54-12425 F
MTr	265x266.1	Casio 309A 321
MTr	270x310.1	Citizen 41-1051
MTr	271x277.2	Dugena A 1648.0
MTr	271x277.1	Dugena A 1648.0
MTr	271x311.1	Citizen 54-75580
MTs	279x279.1	Junghans 1352
MTr	280x300.1	Rico 826001/PW 2021
MTs	282x278.1	
MTr	285x314.1	Citizen 54-76960
MTr	289x239.1	Citizen 54-98420
MTr	290x280.1	Junghans 42.197-0894
MT	290x290.1	Rico 823007
MTs	300x240.1	Citizen 54-77430S
MTr	308x240.1	Dugena Prätina P322

# Form Mineral – Fancy Mineral



## Ballenform / Bale shape

Order-Nr.		Marke
MBr	139X139.1	
MBs	139X139.1	
MBr	140X140.1	
MBr	144x125.1	Aristo 11600
MBs	146X146.1	
MBr	149x149.1	Orient 16-2379
MBs	154x154.1	Aristo 11900
MBr	156X156.1	
MBr	157X139.1	
MBr	158x148.1	Citizen 54-59910
MBr	163X145.1	
MBs	163X163.1	
MBr	164X164.1	
MBs	167x158.1	Citizen
MBr	169x154.1	Junghans 1389
MBs	170X152.1	
MBs	171x133.1	Aristo 12400
MBr	171X146.1	
MBr	174X149.1	
MBr	175x175.1	Aristo 16800
MBr	176x141.1	Aristo 11800
MBr	176X176.1	
MBr	180x157.1	Citizen
MBr	181x176.1	Dugena E2201.010
MBr	181X181.1	
MBr	184x184.1	Dugena 99 1031
MBr	185x185.1	Dugena 99 1011
MBr	185X185.2	Citizen
MBr	187x187.1	Seiko SA3N 34 GNOO
MBr	189X189.1	
MBr	190X149.1	
MBs	190x175.1	Citizen 54-77470 S
MBr	192x172.1	Aristo 1300
MBs	192x192.1	Citizen
MBr	193x173.1	Citizen 54-58330
MBr	198X198.1	
MBs	199x188.1	Aristo 1350/60
MBr	199X194.1	
MBs	199X201.1	
MBr	200X175.1	Seiko SA3N 00 GNOO
MBr	200x185.1	Citizen 54-77470 S
MBr	200X200.1	
MBr	202X202.1	
MBs	212x182.1	Aristo 1390
MBr	214X188.1	
MBr	220x200.1	Seiko SA3W 22GN
MBr	230x230.1	Citizen 54-94230
MRs	231x221.1	Orient 16-2160
MBr	235x180.1	Citizen 54-17895F
MBr	244X244.1	Seiko SA3N 40 GNOO
MBs	245x230.1	Orient 16-2219
MBr	247x131.1	Junghans 42197-1304
MBs	249x229.1	Orient 16-2410
MBs	253X288.1	Seiko ES1W 14 GNOO
MBs	254X249.1	
MB	255x255.1	Rico PW 891
MBr	257X246.1	Seiko SA3N 42 GNOO
MBs	259x244.1	Orient 16-2363

Order-Nr.		Marke
MBr	268X268.1	
MBr	270X220.1	Seiko RE6N 97 LNOO
MBr	270x270.1	Dugena 891 133
MBr	274X254.1	Seiko SA1N 38 GNOO
MBr	274x274.1	Citizen 54-19275F
MB	274x304.1	Citizen 40-4179 40-98056KA 9061578
MBr	275X255.1	Seiko SA3W 44 GNOO
MBr	278X278.1	
MBr	279x239.1	Junghans 42197-1278
MBs	279x260.1	Junghans 1260
MBr	280x235.1	Citizen 54-77750 S
MBr	280X280.1	Junghans 1257
MBr	280x280.2	Junghans 1257.
MBr	281x241.1	Citizen 54-99405 G
MBr	284x263.1	Junghans 42197-1304
MBr	284X284.1	
MBr	285X245.1	Seiko ESJN 07 HNOO
MB	285X265.1	
MBs	287x256.1	Aristo 2190
MBr	288X268.1	Seiko SA2W 14 GNOO
MBr	289x269.1	Junghans 1415
MBs	289x279.1	Junghans 1313
MBr	289x289.1	Dugena A3I16.442
MBr	290x248.1	Citizen 54-31505
MBr	290X250.1	
MB	290X252.1	
MB	290x260.1	Juta
MBr	290X260.2	
MBr	290X275.1	Seiko SA2W 27 HNOO
MBr	290X290.1	
MBr	290X290.2	
MBr	291X256.1	Seiko SA3N 50GN
MBs	294.259.1	Citizen 54-U0016
MBr	294x276.1	Citizen 54-6055
MBr	294x292.1	Junghans 0931
MBr	295x210.1	Orient 16-1038
MBr	295x230.1	RP 2111
MBr	295x235.1	Citizen 54-77440 S
MBr	300x250.1	Dugena U022.511 225
MBr	300x250.2	Citizen 54-76580
MBr	300X295.1	
MBr	300X300.1	
MBs	300X300.1	
MBr	302X281.1	
MBr	304x289.1	Citizen 54-94200
MBr	308X263.1	Seiko SA1W 50 GNOO
MBr	310x223.1	Citizen 54-76940
MBr	310x300.1	Citizen 54-74820
MBr	313X274.1	Seiko SA1W00 GNOO
MBr	314X314.1	Seiko SA1W 77 HNOO
MBr	314X314.2	Seiko SAOW 64 GNOO
MB	317x317.1	Dugena U3164.518
MB	320x290.1	Dugena 834373
MBr	329X264.1	Seiko SA1W 06 GNOO
MBr	330x240.1	Citizen 54-79170
MBr	330x250.1	Certina 778 0001 41 DD
MBr	330X270.1	
MBr	334X269.1	Seiko SAOW 82GN
MBr	334x293.1	Citizen 342144/296



# Form Mineral – Fancy Mineral



## Ellipsenform / Elliptical shape

Order - Nr:		Marke
ME	153x101.1	Aristo 3800
ME	171x145.1	Aristo 1280
ME	173x143.1	
ME	174x142-1	
ME	180x147.1	
ME	188x148.1	Citizen
ME	194x163.1	Dugena 991021
ME	194x164.1	
ME	197x163.1	Dugena 991041
ME	199x174.1	
ME	200x150.1	
ME	206x184.1	
ME	228x207.1	Dugena V 2200.528
ME	342x312.1	Dugena U3162618
ME	354x304.1	Orient 16-1387
ME	354x324.1	Orient 16-1260
ME	382x302.2	Dugena 3450.618
ME	382x302.1	

## Hufeisenform / Horseshoe shape



MH 179x172.1

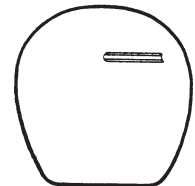

MH 243x242.1

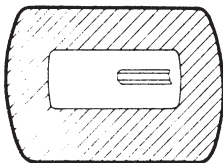

LCD-MT 212x302.1

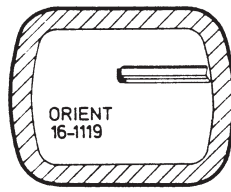

LCD-MTr 241x301.1

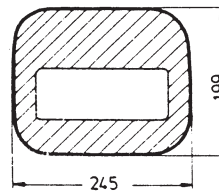

LCD-MBr 245x199.1  
Dugena 869 384  
schwarz-weißer Druck  
black-white print

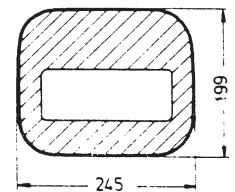

LCD-MBr 245x199.2  
Dugena A 9922.321  
braun-goldener Druck  
brown-gold print

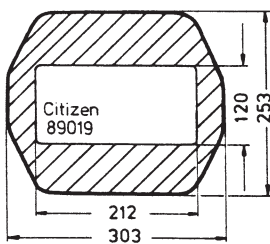

LCD-MT 253x303.1

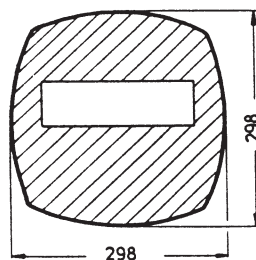

LCD-MB 298x298.1  
Dugena A 8905.211

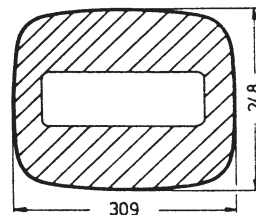

LCD-MBr 309x248.1  
Dugena X 2710.211

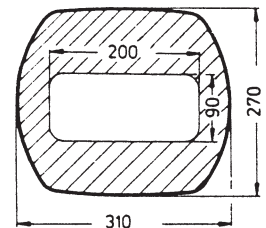

LCD-MBr 310x270.1  
Citizen 54-80415

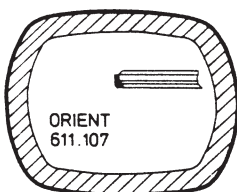

LCD-MBr 321x261.1

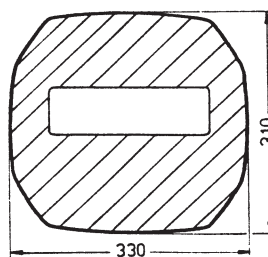

LCD-MBs 330x310.1  
Dugena A 8911-111

# Saphirgläser – Sapphire Glasses



- flach / flat
- SR 170 - SR 210, Stärke / thickness 0.8 mm
  - SR 211 - SR 320, Stärke / thickness 0,9 mm
- Zusätzlich / additionally SR 325, Stärke / thickness 0,9 mm

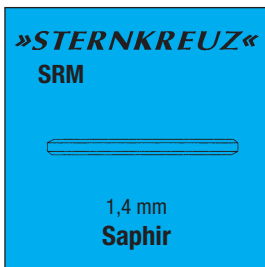

- flach / flat
- SRM 260 - SRM 320, Stärke /thickness 1,4 mm

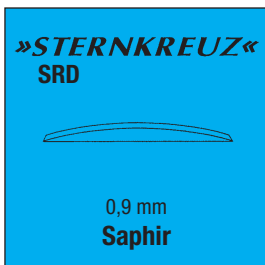

- gewölbt / domed
- SRD 260 - SRD 320, Stärke /thickness 0,9 mm

Wir bieten Ihnen die Saphirgläser auch als Sortiment wie folgt an:  
We also offer the sapphire glasses in assortments as follows:  
SR - 152 Nr. à 1 Stück von 170 bis 320 u.325  
SR - 152 Nos. à 1 pc. each from 170 to 320 and 325

SRM 61 Nr. à 1 Stück von 260 bis 320  
SRM - 61 Nos. à 1 pc. each from 260 to 320

SRD - 61 Nr. à 1 Stück von 260 bis 320  
SRD - 61 Nos. à 1 pc. each from 260 to 320

# Rund Kunststoff zum Einsprengen Round Plastic Snap-In Glass

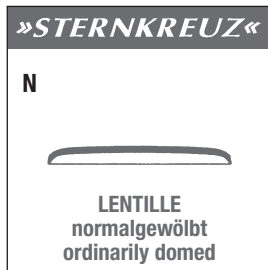

**N**

- N 95 – N 160
- N 162 – N 500



**CG**

- CG 180 – CG 340

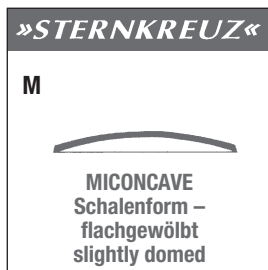

**M**

- M 164 – M 500



**C**

- C 95 – C 160
- C 162 – C 220

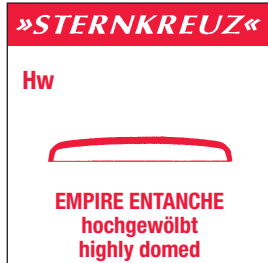

**Hw**

- Hw 120 – Hw 140
- Hw 142 – Hw 400



**CP**

- CP 110 – CP 160
- CP 162 – CP 210
- CP 314 – CP 322



**HwS**

- HwS 120 – HwS 140
- HwS 142 – HwS 400

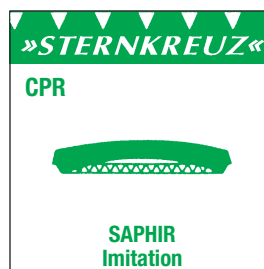

**CPR**

- CPR 110 – CPR 160
- CPR 162 – CPR 210
- CPR 312



**HH**

- HH 250 – HH 340



**Sav**

- Sav 200 – Sav 500
- Sav 401 – Sav 429

ALLE NUMMERN LIEFERBAR / ALL NUMBERS AVAILABLE ·  ALLE GERADEN NUMMERN LIEFERBAR / ALL EVEN NUMBERS AVAILABLE

# Rund Kunststoff zum Einsprengen Round Plastic for tension fitting



a = 1. Maß: Außendurchmesser  
b = 2. Maß: Abstand der Lupenmitte zur Glasmitte

a = 1 St. measurement: outside diameter  
b = 2nd. measurement: distance from centre of lens to centre of glass

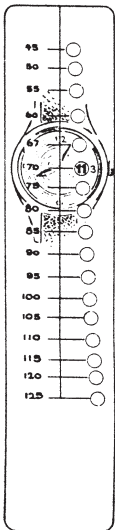
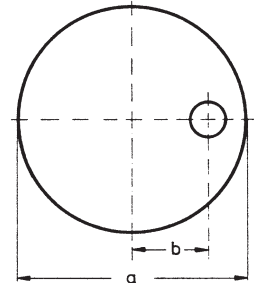

LIEFERBARE GRÖSSEN / AVAILABLE SIZES					
CL 192/055	CL 270/105	CLH 284/095	CL 296/100	CL 306/115	
CLH 200/055	CLH 272/067	CL 284/100	CL 296/105	CL 308/095	
CLH 202/055	CL 272/085	CL 284/105	CL 296/110	CL 308/100	
CLH 204/055	CLH 272/095	CL 286/067	CL 298/067	CL 308/105	
CLH 234/067	CL 272/105	CLH 286/070	CLH 298/070	CL 308/110	
CL 236/067	CLH 274/067	CLH 286/075	CL 298/080	CL 308/115	
CL 236/075	CL 274/070	CL 286/085	CL 298/085	CL 310/085	
CL 238/067	CL 274/085	CLH 286/095	CL 298/095	CL 310/100	
CL 238/075	CL 274/095	CL 286/100	CL 298/100	CL 310/105	
CL 240/067	CL 274/100	CL 286/105	CL 298/105	CL 310/110	
CL 240/075	CL 274/105	CL 288/067	CLH 300/067	CL 312/067	
CL 242/085	CL 276/070	CLH 288/070	CLH 300/070	CL 312/095	
CLH 244/075	CL 276/075	CL 288/100	CL 300/075	CL 312/100	
CL 250/070	CL 276/085	CL 290/067	CL 300/085	CL 312/105	
CLH 252/045	CL 276/095	CLH 290/075	CL 300/090	CL 312/110	
CL 252/067	CL 276/100	CL 290/080	CL 300/095	CL 312/115	
CL 252/070	CL 276/105	CL 290/100	CL 300/100	CLH 314/085	
CLH 254/045	CLH 278/067	CL 290/105	CL 300/105	CL 314/095	
CL 254/067	CL 278/075	CL 290/110	CL 300/110	CL 314/100	
CL 254/075	CL 278/085	CLH 292/070	CLH 302/067	CL 314/105	
CL 256/075	CLH 278/090	CL 292/080	CLH 302/070	CL 314/115	
CLH 260/070	CL 278/095	CLH 292/085	CL 302/075	CL 316/095	
CLH 260/075	CL 278/100	CL 292/095	CL 302/090	CL 316/100	
CLH 262/067	CL 280/067	CL 292/100	CL 302/095	CL 316/110	
CLH 262/070	CLH 280/070	CL 292/105	CL 302/100	CL 316/115	
CLH 262/080	CL 280/075	CL 292/110	CL 302/105	CL 318/100	
CLH 262/095	CL 280/085	CL 294/067	CL 302/115	CLH 318/105	
CLH 264/067	CLH 280/090	CLH 294/070	CLH 304/067	CL 318/115	
CLH 264/070	CL 280/095	CL 294/080	CL 304/090	CL 320/100	
CLH 266/067	CL 280/105	CLH 294/085	CL 304/095	CL 320/115	
CLH 266/070	CL 280/110	CLH 294/095	CL 304/100	CLH 322/095	
CLH 266/075	CL 282/067	CL 294/100	CL 304/105	CL 322/100	
CLH 266/080	CLH 282/070	CL 294/105	CL 304/110	CL 324/100	
CLH 268/067	CL 282/085	CL 294/110	CL 304/115	CLH 326/095	
CLH 268/070	CL 282/095	CL 296/067	CLH 306/067	CLH 330/115	
CLH 286/085	CL 282/105	CL 296/075	CL 306/095	CLH 330/105	
CLH 268/095	CL 284/067	CL 296/080	CL 306/100	CLH 344/095	
CL 268/105	CLH 284/070	CL 296/085	CL 306/105	CLH 362/085	
CL 270/100	CL 284/085	CL 296/095	CL 306/110	CLH 362/095	

Andere Abmessungen mit runden innenliegenden Lupen können gegen Mehrpreis von der Fabrik hergestellt werden.

Den notwendigen Lupenabstand misst man mit der Lupenlehre.

Any other sizes with round interior lenses can be supplied at a small surcharge.

The necessary distance of the lens is measured with the lens gauge.

# Rund-Sonderform Kunststoff zum Einsprengen Special Forms Round Plastic Snap-In Glass



**»STERNKREUZ«**

**X**

**Einsprengglas**  
Rundglas-Sonderform  
SNAP-IN GLASS  
Special form round

Bestellnummer  
Ordering number

X 315.025 |

Nach dem Außendurchmesser sind die Gläser geordnet.  
The Glasses are in order of their outside diameters.

Laufende Ordnungsnummer  
Current number

Preisgruppe  
Price group

Alle Durchmesser sind in Zehntelmillimeter angegeben.  
Bitte beachten Sie den Marken- und Kaliberschlüssel.  
Unter den Bildern finden Sie Hinweise auf passende Gehäuse.

Diameters are expressed in terms of tenth of millimetres.  
Please note the key to brands and calibres.  
Below the illustrations you can find references to suitable cases.

X 157.066 |

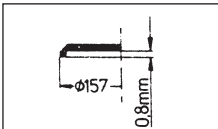

Aristo 1207.1208

X 161.046 |

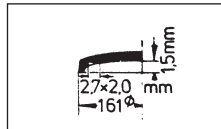

Provita

X 162.067 |

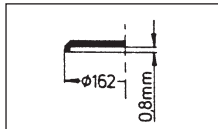

Aristo 1205

X 169.042 |

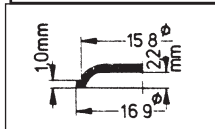

X 195.023 |

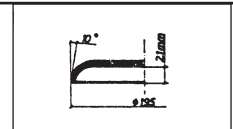

Kienzle 09 12/16  
15 12/16

X 195.001 |

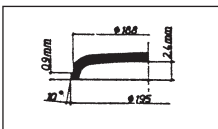

Zentra

X 199.043 |

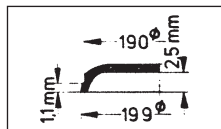

X 202.064 |

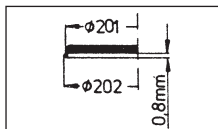

Junghans 1114

X 207.002 |

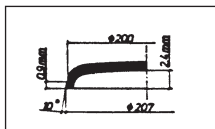

Zentra

X 218.014 |

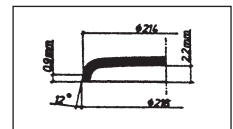

Laco 261/71/4

X 223.057 |

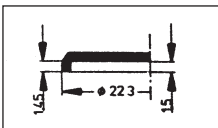

Citizen 85-2139

X 224.049 |

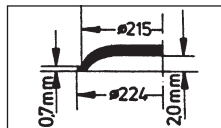

Diehl 42.197-0563

X 269.047 |

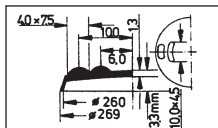

Westend Modell 64

X 275.039 |

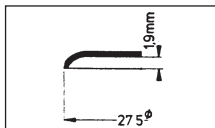

Kienzle 01 52/56

X 276.035 |

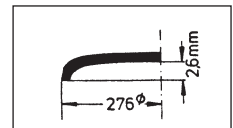

for Rolex Tropic 26

X 279.048 |

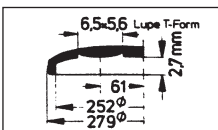

Westend Modell 1974

X 280.024 |

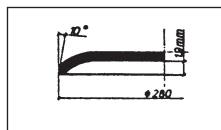

Kienzle 08 13/17

X 285.038 |

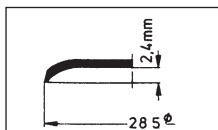

Kienzle 08/41

X 289.068 |

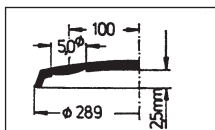

X 292.003 |

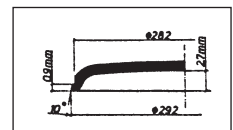

Zentra

X 292.021 |

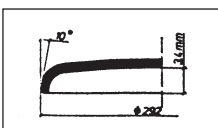

Kasper Cal. 901

X 302.020 |

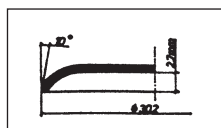

Kienzle 01/42.01/32

X 305.045 |

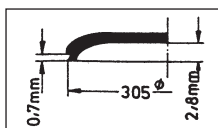

X 305.063 |

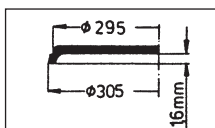

Junghans 1086

X 309.060 |

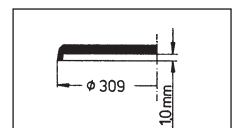

Junghans 1097

X 301.028 |

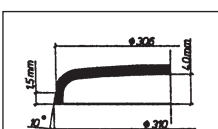

Junghans 93/1954

X 312.013 |

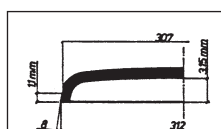

Aristo

X 312.027 |

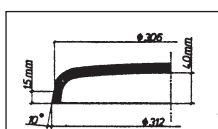

Junghans 93/1954

X 313.062 |

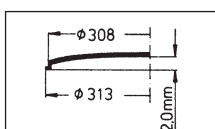

Junghans 1962

X 314.006 |

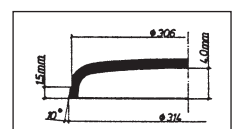

Junghans 93/1954

# Rund-Sonderform Kunststoff zum Einsprengen Special Forms Round Plastic Snap-In Glass

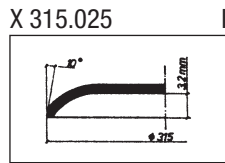

X 315.025 | Kienzle 08 62/66

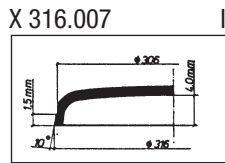

X 316.007 | Junghans 93/1954

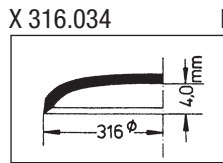

X 316.034 | Kienzle 051/N/52,53

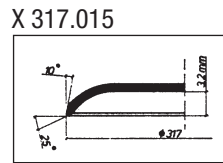

X 317.015 | Zentra

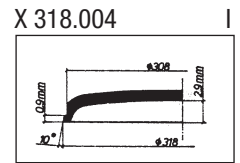

X 318.004 | Junghans 93/1954

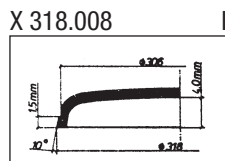

X 318.008 | Aristo

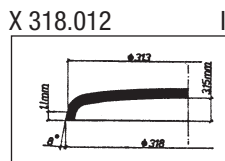

X 318.012 | Junghans

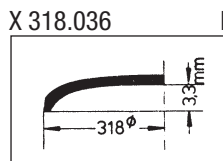

X 318.036 | Laco electric

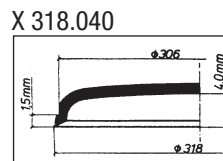

X 318.040 | Laco electric

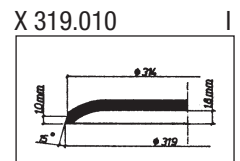

X 319.010 | Seiko 318 N 02 AN

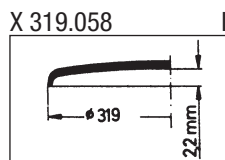

X 319.058 | Porta 261

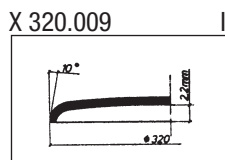

X 320.009 | Kienzle 08 42,46

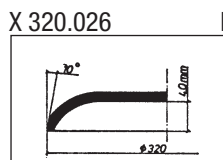

X 320.026 | Osco S

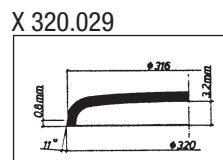

X 320.029 | X 320.030

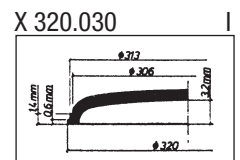

X 320.030 | Kienzle 840 4700

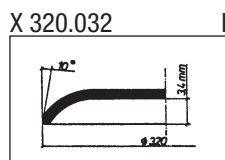

X 320.032 | Junghans

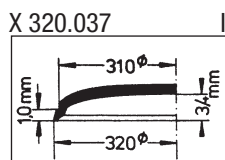

X 320.037 | Arctos

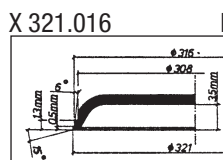

X 321.016 | X 322.022

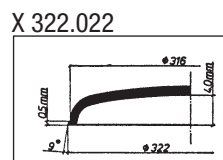

X 322.022 | X 322.033

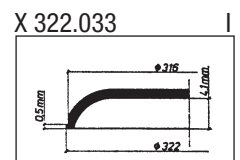

X 322.033 | Kienzle 840 4700

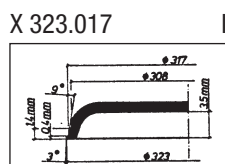

X 323.017 | Laco 870

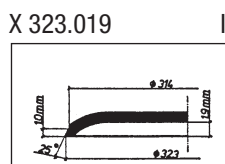

X 323.019 | X 323.031

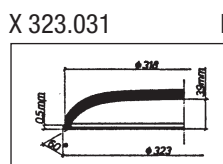

X 323.031 | X 325.005

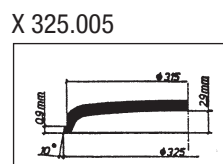

X 325.005 | X 325.050

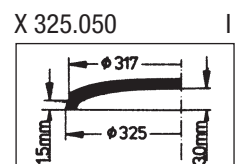

X 325.050 | Junghans 0879

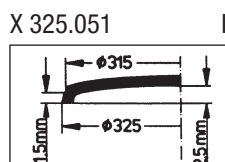

X 325.051 | Junghans 833

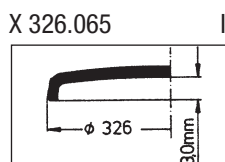

X 326.065 | Laco Mechanic

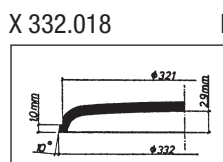

X 332.018 | Seiko 338 NO 1AN

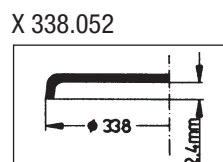

X 338.052 | Seiko 340 N 05 AN

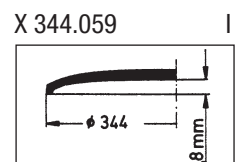

X 344.059 | Maurice Guerdat No. 32 58/3

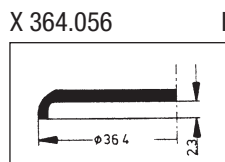

X 364.056 | Maurice Guerdat No. 32 58/3

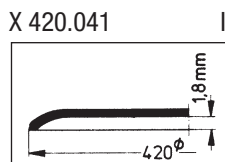

X 420.041 | Kienzle 146/30

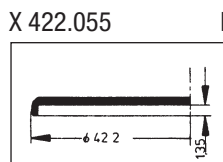

X 422.055 | Maurice Guerdat No. 32 59/4

# Rund Kunststoff – Round Plastic Stülpglas – Topglass



a = 1. Maß: Außen-  
durchmesser

a = 1st. measurement:  
outside diameter

LIEFERBARE GRÖSSEN / AVAILABLE SIZES					
ST 182/171	ST 260/248	ST 280/264	ST 290/278	ST 296/286	ST 310/295
ST 184/173	ST 260/252	ST 280/265	ST 290/282	ST 297/284	ST 310/297
ST 194/184	ST 260/250	ST 282/266	ST 290/280	ST 297/286	ST 310/296
ST 195/185	ST 261/248	ST 282/271	ST 290/274	ST 298/286	ST 311/295
ST 215/204	ST 268/252	ST 282/270	ST 291/275	ST 299/283	ST 312/300
ST 217/206	ST 270/254	ST 282/266	ST 291/280	ST 300/285	ST 315/299
ST 218/207	ST 271/255	ST 283/271	ST 292/280	ST 301/288	ST 316/305
ST 218/206	ST 272/256	ST 284/268	ST 292/276	ST 301/285	ST 317/308
ST 219/209	ST 273/257	ST 285/271	ST 293/280	ST 302/288	ST 319/303
ST 230/220	ST 274/258	ST 285/273	ST 293/282	ST 304/292	ST 320/308
ST 246/236	ST 275/259	ST 285/272	ST 293/281	ST 304/288	ST 322/309
ST 248/232	ST 275/262	ST 286/273	ST 294/281	ST 305/285	ST 322/310
ST 250/234	ST 276/267	ST 286/270	ST 295/283	ST 306/295	ST 330/318
ST 257/249	ST 277/266	ST 288/272	ST 295/282	ST 307/295	
ST 259/248	ST 277/261	ST 289/276	ST 295/285	ST 309/293	
ST 260/249	ST 279/263	ST 289/273	ST 296/288	ST 310/294	

Bei Stülpgläsern ist die Fußstärke  $([a-b] : 2)$  entscheidend für den festen Sitz im Gehäuse. Beachten Sie bitte, daß es zu kurannten Außendurchmessern verschiedene Innendurchmesser (also verschiedene Fußstärken) gibt.

With top glasses, the thickness of the base determines the tight fit in the case. Please note that there are different inside diameters (i. e. different thicknesses of the base) for one and the same outside diameter.



Bestellnummer  
Ordering Number

XS 538.122 II

Nach dem Außendurchmesser sind die Gläser geordnet.  
The Glasses are in order of their outside diameters.

Laufende Ordnungsnummer  
Current number

Preisgruppe  
Price group

Alle Durchmesser sind in Zehntelmillimeter angegeben. Bitte beachten Sie den Marken- und Kaliberschlüssel. Unter den Bildern finden Sie Hinweise auf passende Gehäuse.

Diameters are expressed in terms of tenth of millimetres. Please note the key to brands and calibres. Below the illustrations you can find references to suitable cases.

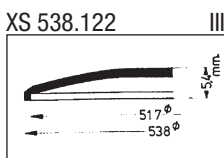

Hanhart

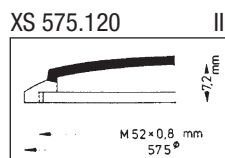

Hanhart Kal. 1021

Für die richtige Auswahl von Stülpgläsern müssen Sie zusätzlich den notwendigen Innendurchmesser genau messen.

For the correct choice of top glasses one has to measure the appropriate inside diameter carefully.

# Rund Sonderform Kunststoff Stülpglas Round Special Forms Plastic Topglass



XS 178.198 II

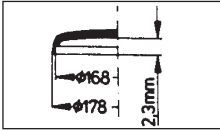

ROAMER X 7184

XS 180.471 II

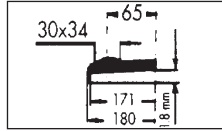

for Rolex Cyclop 122

XS 191.186 II

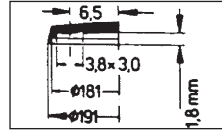

SEIKO 190 W01 AL

XS 195.414 II

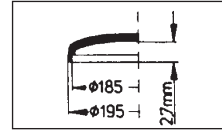

ROAMER X 7149

XS 195.415 II

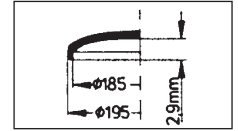

ROAMER X 7161

XS 196.136 II

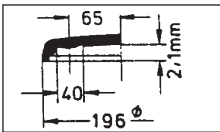

Seiko 195 W 01 ALO

XS 196.444 II

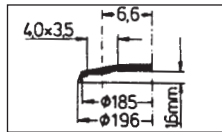

Seiko 195 W 07 ALOO

XS 200.452 II

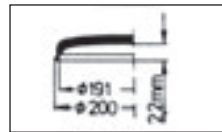

for Rolex Tropic 3

XS 201.406 II

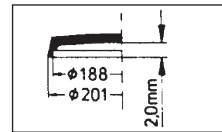

SEIKO 200 W0 1AN

XS 204.419 II

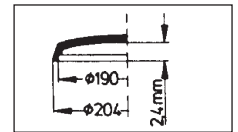

ORIENT 05-711 OS-718  
FY001 GA

XS 205.447 II

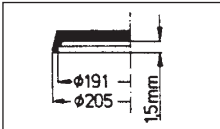

Citizen 54-01800

XS 210.421 II



ORIENT OS-729 FY002GA

XS 211.460 II

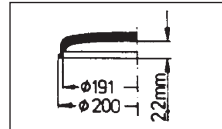

for Rolex Cyclop 121

XS 215.428 II

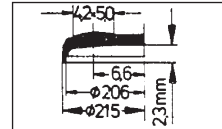

for Rolex Cyclop 101

XS 215.429 II

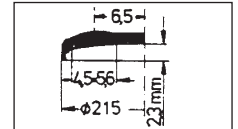

ROLEX Cyclop 129

XS 216.466 II

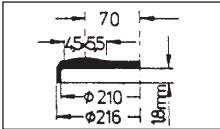

for Rolex Tropic 7

XS 217.458 II

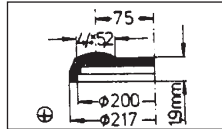

for Roieix Imitation

XS 218.411 II

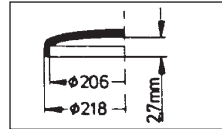

ROAMER X 7100

XS 248.468 II

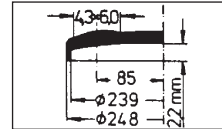

for Rolex Cyclop 103

XS 253.455 II

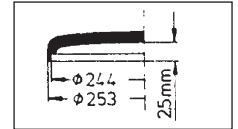

for Rolex Tropic 7

XS 255.456 II

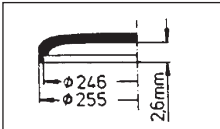

for Rolex Tropic 30

XS 256.129 II

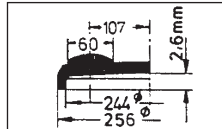

for Rolex Cyclop 104/105

XS 260.100 II

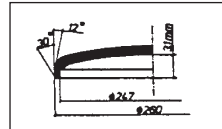

Roamer X7103

XS 260.116 II

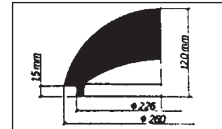

for Rolex Tropic 11

XS 265.446 II

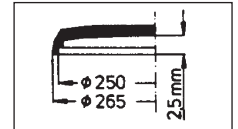

Citizen 54-01870

XS 268.410 II

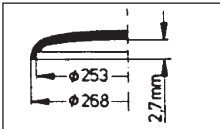

SEIKO 266 W0 1AN

XS 275.467 II

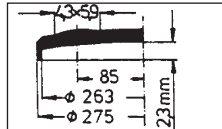

for Rolex Cyclop 106

XS 280.101 II

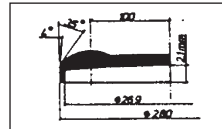

for Rolex Cyclop 107

XS 292.155 II

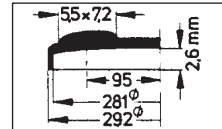

for Rolex Cyclop 108

XS 292.470 II

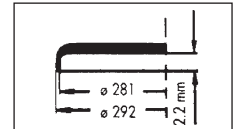

for Rolex Tropic 11

XS 293.102 II

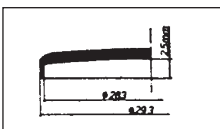

for Rolex Tropic 14

XS 293.103 II

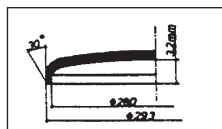

Roamer X 7106  
X 7132

XS 293.134 II

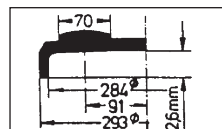

for Rolex Cyclop 111

XS 293.156 II

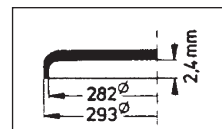

for Rolex Tropic 12

XS 294.110 II

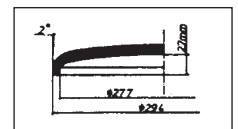

Citizen 51-102



# Rund Sonderform Kunststoff Stülpglas Round Special Forms Plastic Topglass



XS 294.431 II

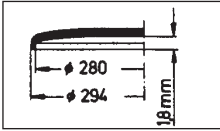

Mikado 4G 4005

XS 294.440 II

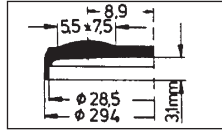

for Rolex Cyclop 123

XS 294.463 II

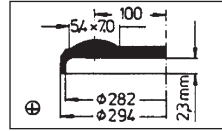

for Rolex Cyclop 117

XS 295.157 II

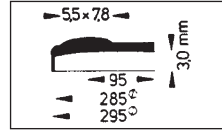

for Rolex Cyclop 117

XS 295.445 II

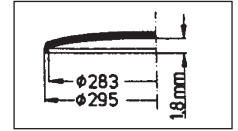

Seiko 293 W01AN00

XS 295.453 II

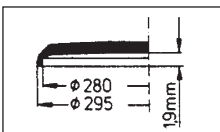

Citizen 01980

XS 295.464 II

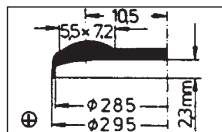

for Rolex Cyclop 112

XS 295.469 II

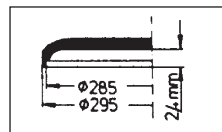

for Rolex Tropic 13

XS 297.174 II

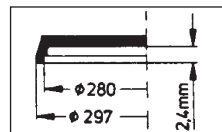

Orient OS-346 m. Drücker  
M 008 61

XS 297.175 II

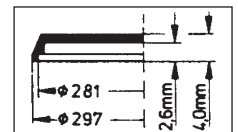

Orient OS-342 m .Drücker

XS 297.459 II

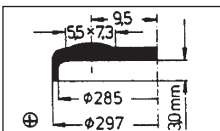

for Rolex Cyclop 145

XS 300.158 II

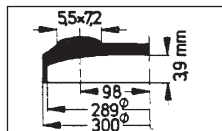

for Rolex Cyclop 112

XS 301.165 II

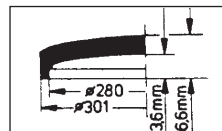

for Rolex Tropic 13

XS 302.196 II

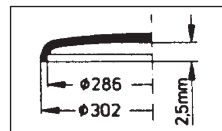

Orient 16-983

XS 302.450 II

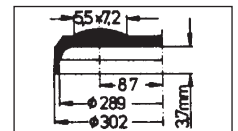

for Rolex Cyclop 116

XS 303.430 II

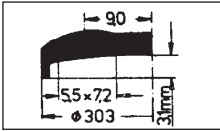

for Rolex Cyclop 127

XS 303.462 II

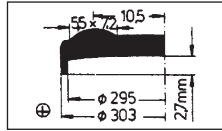

for Rolex Cyclop 125

XS 303.472 II

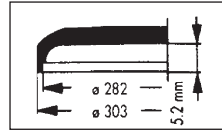

for Rolex Tropic 19

XS 304.465 II

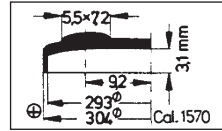

for Rolex Cyclop 114

XS 305.199 II

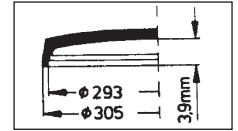

ROAMER X7183

XS 305.451 II

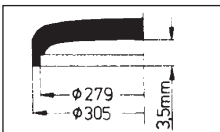

for Rolex Tropic 19

XS 306.133 II

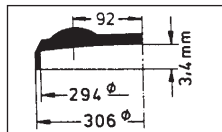

for Rolex Cyclop 118

XS 306.154 II

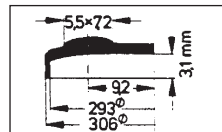

for Rolex Cyclop 114

XS 306.401 II

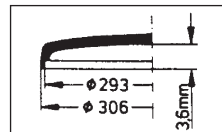

ROAMER X7186

XS 306.402 II

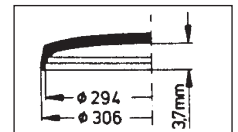

ROAMER X7167

XS 306.449 II

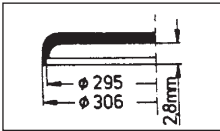

for Rolex Tropic 21

XS 307.457 II

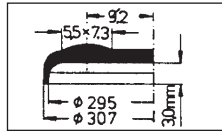

for Rolex Cyclop 135

XS 308.107 II

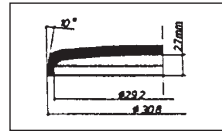

Citizen 31-201

XS 308.176 II

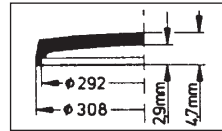

Orient OS-215. M001 GA

XS 308.194 II

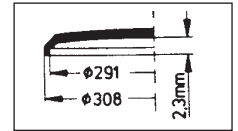

Orient 16-265 16-105 P

XS 309.164 II

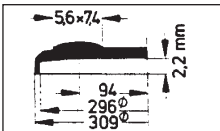

Ricoh 038.104

XS 310.104 II

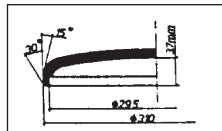

Roamer  
X7156. X7125 X7136

XS 310.109 II

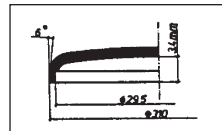

Citizen 51-201

XS 310.177 II

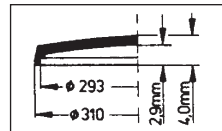

Orient OS-212  
m.u.o Dr. M001 GA

XS 310.178 II

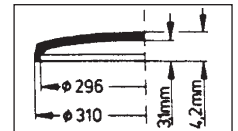

Orient OS-217  
M001 GA

# Rund Sonderform Kunststoff Stülpglas

## Round Special Forms Plastic Topglass



<p>XS 310.403 II</p> <p>ROAMER X 7148</p>	<p>XS 310.412 II</p> <p>ROAMER X7108</p>	<p>XS 310.413 II</p> <p>ROAMER X 7147</p>	<p>XS 310.426 II</p> <p>CITIZEN 54-0153</p>	<p>XS 310.427 II</p> <p>Ricoh 038104</p>
<p>XS 310.435 II</p> <p>Seiko 308 W03 AN</p>	<p>XS 310.442 II</p> <p>Citizen 54-01530</p>	<p>XS 310.454 II</p> <p>Ricoh PW 206</p>	<p>XS 311.111 II</p> <p>Citizen</p>	<p>XS 311.191 II</p> <p>ORIENT 16-420 16-239</p>
<p>XS 311.423 II</p> <p>CITIZEN 54-00200</p>	<p>XS 311.448 II</p> <p>Citizen 54-00200</p>	<p>XS 312.106 II</p> <p>Citizen 51-201</p>	<p>XS 312.108 II</p> <p>Citizen 51-203</p>	<p>XS 312.408 II</p> <p>SEIKO 310 W 04 AN</p>
<p>XS 312.436 II</p> <p>Seiko 310 W01 AN</p>	<p>XS 314.179 II</p> <p>ORIENT OS-326 m. Drücker M002 GA</p>	<p>XS 314.180 II</p> <p>ORIENT OS-310 m. Drucker M002 GA</p>	<p>XS 314.181 II</p> <p>ORIENT OS-238, OS-326 M002 GA</p>	<p>XS 314.417 II</p> <p>ORIENT OS-305.OS-308 OS-309 m.Dr.OS-319 m.u.o.Dr. M002GA</p>
<p>XS 316.130 II</p> <p>Roamer</p>	<p>XS 316.131 II</p> <p>Roamer</p>	<p>XS 316.404 II</p> <p>ROAMER X 7170</p>	<p>XS 316.432 II</p> <p>Mikado 4G 4011</p>	<p>XS 317.407 II</p> <p>SEIKO 315 WO 2AN</p>
<p>XS 319.182 II</p> <p>ORIENT OS-329OS-318 m.Drucker, MO04 GA</p>	<p>XS 319.183 II</p> <p>ORIENT OS-215, OS-252, OS-322 m.Drucker, MO04 GA</p>	<p>XS 319.184 II</p> <p>ORIENT OS-227, OS-327 OS-541 m.Drucker, MO04 GA</p>	<p>XS 319.416 II</p> <p>ORIENT OS-337 m. Drucker MO04 GA</p>	<p>XS 320.189 II</p>
<p>XS 321.159 II</p>	<p>XS 321.424 II</p> <p>CITIZEN 54-0046</p>	<p>XS 322.114 II</p> <p>Seiko 45120 555</p>	<p>XS 322.409 II</p> <p>SEIKO 320 WO 3AN</p>	<p>XS 322.422 II</p> <p>SEIKO 320 WO SAN</p>

# Rund Sonderform Kunststoff Stülpglas

## Round Special Forms Plastic Topglass



XS 326.192 II

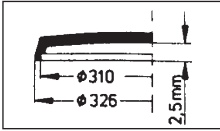

ORIENT 16-419 16-985

XS 327.125 II

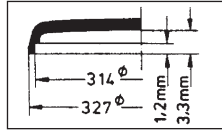

Seiko 325W 04 AN

XS 327.160 II

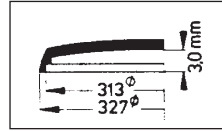

Seiko 325 W06 AN

XS 327.161 II

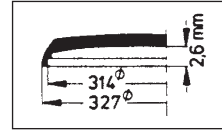

Seiko 325 W 05 AN

XS 329.126 II

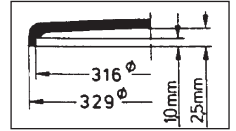

Seiko 327 W 08 AN

XS 329.437 II

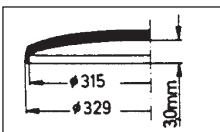

Seiko 327 W01AN 00

XS 330.425 II

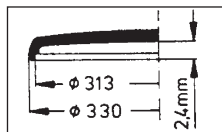

CITIZEN 54-0054

XS 331.438 II

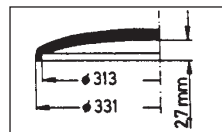

Seiko 329 W01 AN00

XS 332.461 II

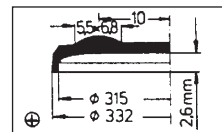

for Rolex Cyclop 124

XS 335.113 II

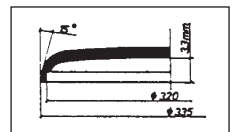

Orient 16-418

XS 336.195 II

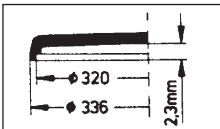

ORIENT 16-966

XS 336.197 II

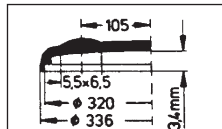

ORIENT 16-959

XS 336.418 II

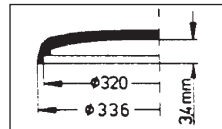

ORIENT 16-991

XS 337.127 II

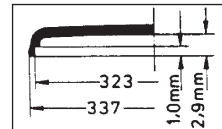

Seiko 335 W 01 AN

XS 340.112 II

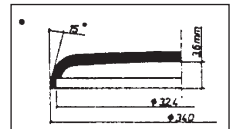

Orient 16-924

XS 340.132 II

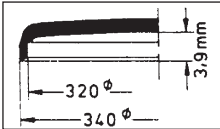

Roamer

XS 340.443 II

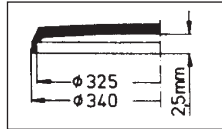

Citizen 54-01260

XS 342.105 II

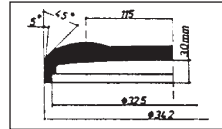

Citizen 55-513

XS 342.128 II

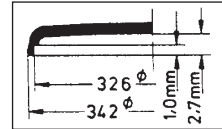

Seiko 340 W 02 AN

XS 342.162 II

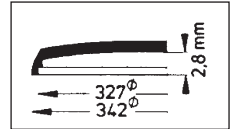

Seiko 340W06 AN00

XS 343.439 II

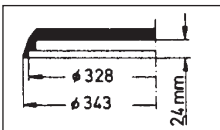

Seiko 341 W02 AN

XS 350.433 II

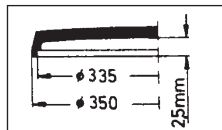

Mikado 4G 4014

XS 352.188 II

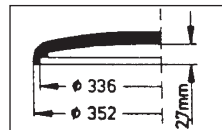

RICOH

XS 355.124 II

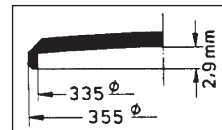

Seiko

XS 356.405 II

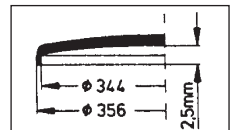

Roamer X 7318

XS 375.190 II

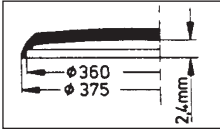

ORIENT 16-244

XS 385.441 II

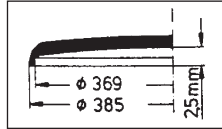

Orient 16-588

XS 389.434 II

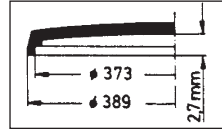

Mikado 4G 4016

XS 390.119 II

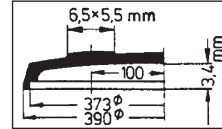

Orient 16-916

XS 390.123 II

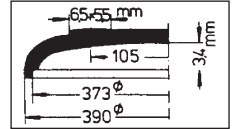

Orient 16-870

XS 390.135 II

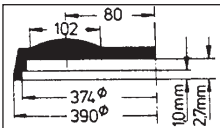

ORIENT 16-017

XS 390.163 II

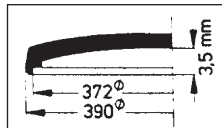

Orient 16-974

XS 395.193 II

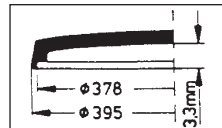

ORIENT 16-478

XS 485.115 III

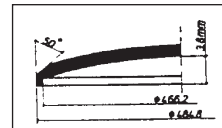

Hanhart Kal. 1022

XS 491.121 III

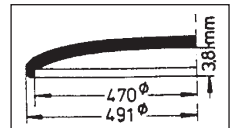

Hanhart Kal. 1012

# Rund Kunststoff armiert Round Plastic armed



**DIA-C** ○ DIA-C 160 –  
DIA-C 352  
patentrechtlich  
geschützt,  
patented



**DIA-G** ○ DIA-G 160 –  
DIA-G 352  
patentrechtlich  
geschützt,  
patented



**DIA-CF** ○ DIA-CF 180 –  
DIA-CF 352  
patentrechtlich  
geschützt,  
patented



**DIA-GF** ○ DIA-GF 180 –  
DIA-GF 352  
patentrechtlich  
geschützt,  
patented



**ATC** ○ ATC 141 –  
ATC 373



**ATG** ○ ATG 141 –  
ATG 373



**ATCH** ○ ATCH 270 –  
ATCH 336



**ATGH** ○ ATGH 270 –  
ATGH 336



**ATCR** ○ ATCR 170 –  
ATCR 206  
○ ATCR 269 –  
ATCR 333



**ATGR** ○ ATGR 170 –  
ATGR 206  
○ ATGR 269 –  
ATGR 333

# Rund Kunststoff armiert Round Plastic armed



**ATCB** ○ ATCB 284 –  
ATCB 343



**ATGB** ○ ATGB 284 –  
ATGB 343



**ACL** ○ ACL 280 –  
ACL 335



**AGL** ○ AGL 280 –  
AGL 335



**ATCT** ○ ATCT 180 –  
ATCT 352

# Rund-Sonderform Kunststoff armiert

## Round Special Forms Plastic Armed



**»STERNKREUZ«**

**XAC**

**ARMIERT - ARMED**  
Rundglas-Sonderform  
Special form round  
Chromring – Chromed ring

**»STERNKREUZ«**

**XAG**

**ARMIERT - ARMED**  
Rundglas-Sonderform  
Special form round  
Goldring – Gilt ring

**»STERNKREUZ«**

**XAO**

**ARMIERT - ARMED**  
Rundglas-Sonderform  
Special form round  
ohne Ring - without ring

Bestellnummer  
Ordering number

XAG 320.502 III

XAC: mit Chromring – with chromed ring  
XAG: mit Goldring – with gilt ring  
XAO: für Armierungsring vorgesehen – aber Lieferung ohne Ring  
provided for armed ring - but delivery without ring

Nach dem Außendurchmesser sind die Gläser geordnet.  
The Glasses are in order of their outside diameters.

Laufende Ordnungsnummer  
Current number

Preisgruppe  
Price group

Alle Durchmesser sind in Zehntelmillimeter angegeben.  
Bitte beachten Sie den Marken- und Kaliberschlüssel.  
Unter den Bildern finden Sie Hinweise auf passende Gehäuse.

Diameters are expressed in terms of tenth of millimetres.  
Please note the key to brands and calibres.  
Below the illustrations you can find references to suitable cases.

XAC 186.682 III

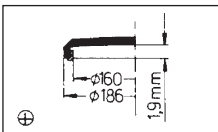

Seiko 185 T05 AASO

XAC 196.574 III

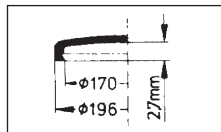

SEIKO 195 07 ANSO

XAC 196.653 III

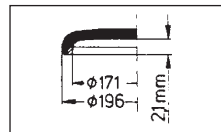

Citizen 54-0578 S/05781 S

XAC 196.665 III

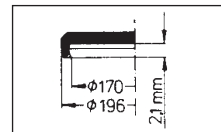

Seiko 195 T03ANSO

XAC 201.587 III



Citizen 54-04201,54-04202

XAG 201.606 III

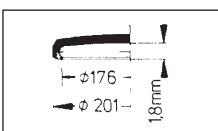

Citizen 54-04201.54-04202

XAC 201.677 III

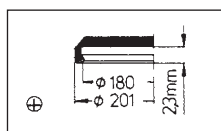

Seiko 200 T04 ANSO

XAG 204.701 III

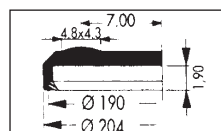

Citizen 54-05142, 54-05141

XAC 206.683 III

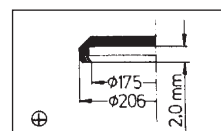

Seiko 205 T25 ANSO

XAG 206.702 III

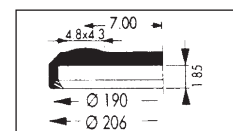

Citizen 54-04941

XAG 206.740 III

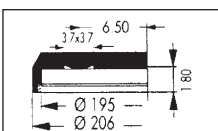

Baume + Mercier

XAG 210.703 III

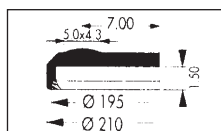

Citizen 54-05142, 54-05141

XAG 211.602 III

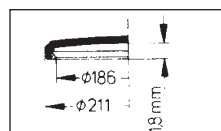

Citizen 54-05142. 54-05141

XAC 211.603 III

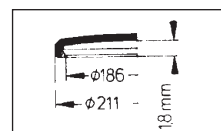

Citizen 54-05142. 54-05141

XAC 211.657 III

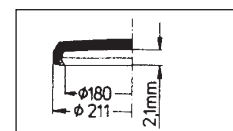

Citizen 54-04941

# Rund-Sonderform Kunststoff armiert

## Round Special Forms Plastic Armed



XAG 211.663 III

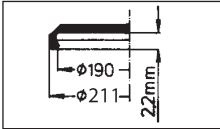

Seiko 210 TO 4ANS

XAC 211.693 III

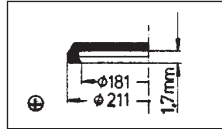

Citizen 54-06151 S

XAG 211.704 III

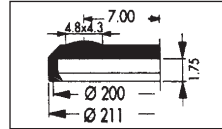

XAG 211.718 III

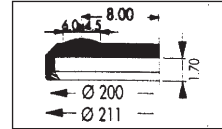

XAG 212.667 III

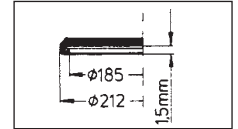

Junghans 1314

XAG 212.668 III

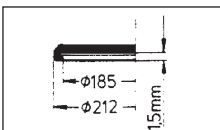

Junghans 1315

XAG 212.705 III

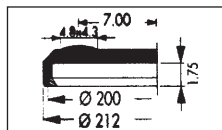

XAG 212.719 III

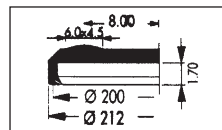

XAG 214.706 III

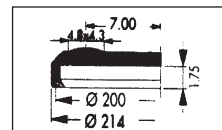

XAG 215.707 III

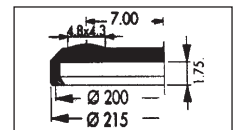

XAG 215.720 III

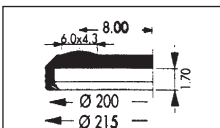

XAG215.742 III

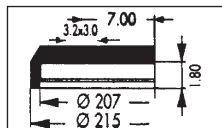

Baume + Mercier

XAG 216.599 III

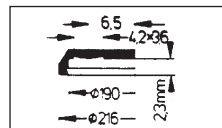

Seiko 215 T 13 AEGO

XAG 216.708 III

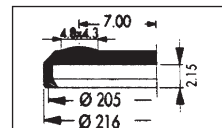

XAG 216.721 III

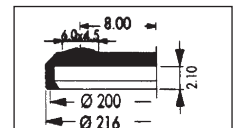

XAG 217.654 III

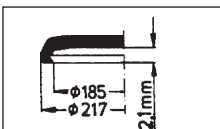

Citizen 54-05911

XAG 217.675 III

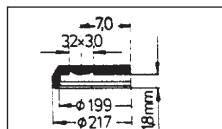

Baume + Mercier 1215

XAG 217.709 III

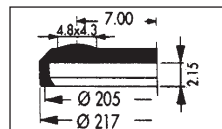

XAG 217.722 III

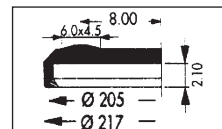

XAG 220.699 III

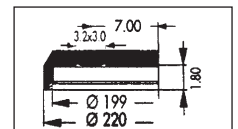

Baume + Mercier

XAG 220.710 III

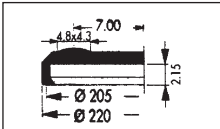

XAC FAC 221.689 III

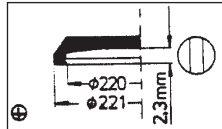

Citizen 54-05491

XAG 221.711 III

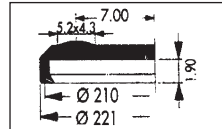

XAG 222.712 III

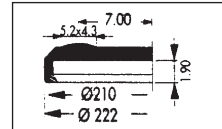

XAG 223.713 III

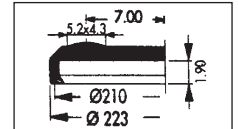

XAG 225.513 III

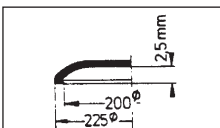

Kienzle 059 11/25

XAC 225.514 III

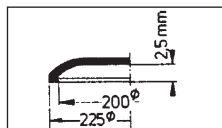

Kienzle 059 11/25

XAG 225.550 III

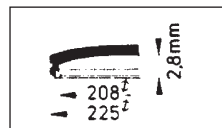

Omega 5117

XAC 225.551 III

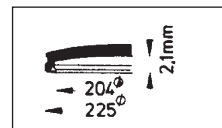

Omega 5116

XAC 225.555 III

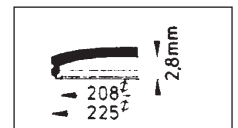

Omega 5117

XAG 225.666 IV



Baume + Mercier 4216

XAC 225.671 III

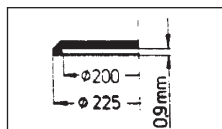

Junghans 1009

XAG 225.672 III

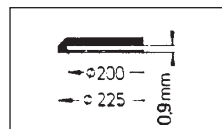

Junghans 1035

XAC 226.662 III

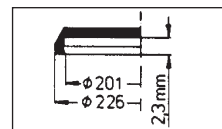

Seiko 225 T01AASO

XAC 227.669 III



Junghans 1316

# Rund-Sonderform Kunststoff armiert Round Special Forms Plastic Armed



XAG 227.670 III

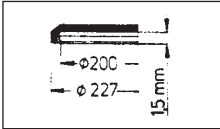

Junghans 1317

XAC 231.658 III

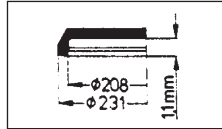

Citizen 54-04221

XAC 231.688 III

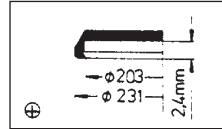

Citizen 54-05351

XAO 235.581 III

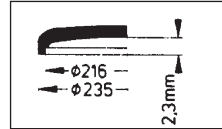

Enicar 771.14.01 ohne Ring

XAG 235.744 III

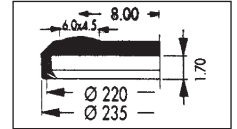

XAC 246.687 III

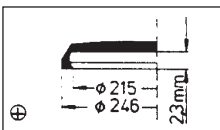

Citizen 54-05341

XAG 250.714 III

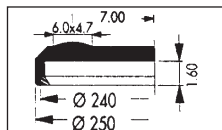

XAG 255.715 III

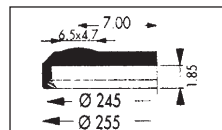

XAG 255.723 III

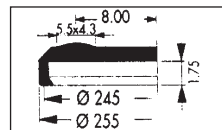

XAG 255.726 III

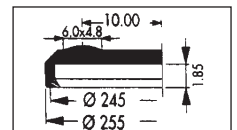

XAG 256.716 III

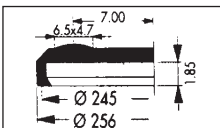

XAG 256.724 III

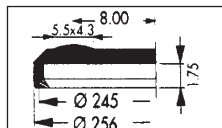

XAG 256.727 III

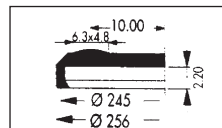

XAG 256.741 III

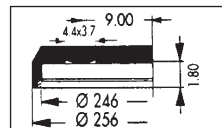

Baume + Mercier

XAG 257.674 III

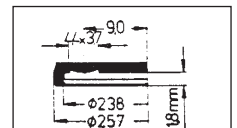

Baume + Mercier 1187

XAG 257.717 III

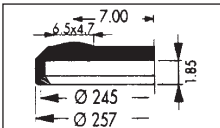

XAG 257.725 III

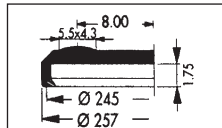

XAG 257.728 III

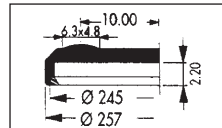

XAG 258.729 III

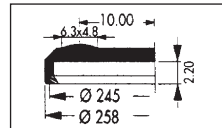

XAG 260.700 III

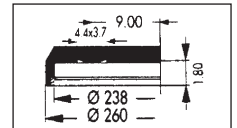

Baume + Mercier 1188

XAG 260.730 III

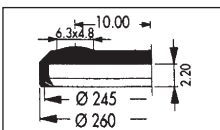

XAG 261.659 III

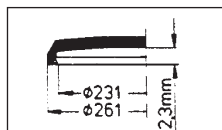

Citizen 54-04241

XAG 261.731 III

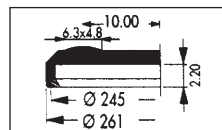

XAG 262.732 III

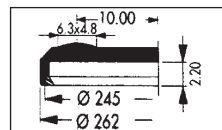

XAG 266.673 IV

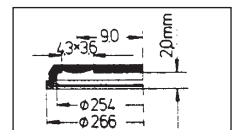

Baume + Mercier 1188

XAG 270.733 III

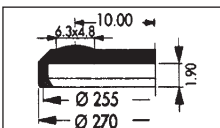

XAG 271.734 III

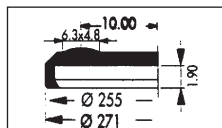

XAO FAC 279.138 III

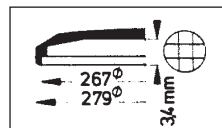

Omax

XAC 279.573 III

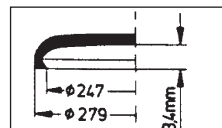

Real 812-6079-2

XAG 280.509 III

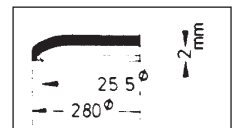

Kienzle 08 13/17

XAC 280.510 III

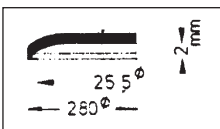

Kienzle 08 13/17

XAO FAC 281.137 III

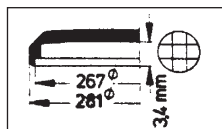

Omax

XAC 281.604 III

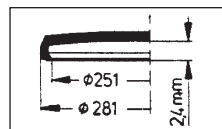

Citizen 54-04281

XAC 283.584 III

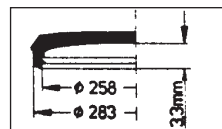

Citizen 54-04801

XAG 286.586 III

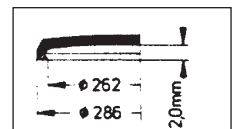

Citizen 54-0408



# Rund-Sonderform Kunststoff armiert Round Special Forms Plastic Armed



XAG FAC 286.609 III

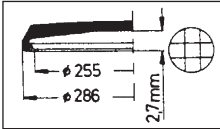

Mikado 4G 3006, Omax

XAC FAC 286.610 III

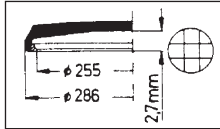

Mikado 4G 3006, Omax

XAC 286.743 III

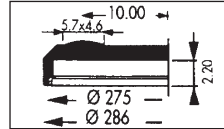

Picot

XAC 287.566 III

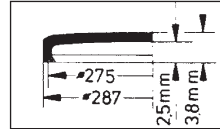

XAC 287.567 III

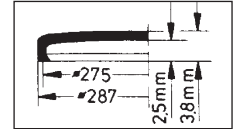

XAC 287.600 III

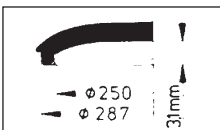

Dugena I 4180 058

XAG 288.589 III

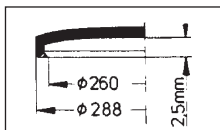

Dugena Monza

XAC 288.590 III

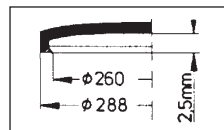

Dugena Monza

XAG 290.735 III

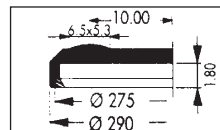

XAC 291.692 III

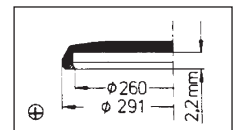

Citizen 54-06121 S

XAC 292.508 III

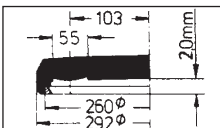

Junghans

XAG 295.736 III

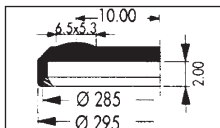

XAG 296.611 III

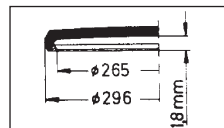

Mikado 4G 3008

XAC 296.612 III

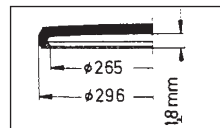

Mikado 4G 3008

XAC 296.691 III

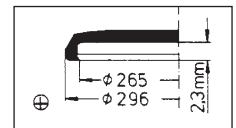

Citizen 54-05921 S

XAC 296.694 III

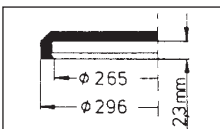

Citizen 54-05361

XAC 297.518 III

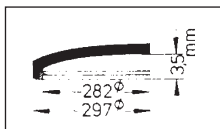

Certina 982/1 29.5-3/5

XAG 297.519 III

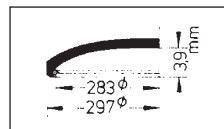

Certina 982/1 29.5-3/1

XAC 297.655 III

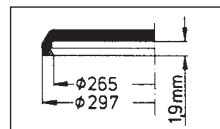

Citizen 54-05721 S

XAO FAC 299.166 III

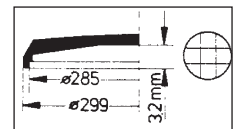

Ricoh

XAC 300.506 III

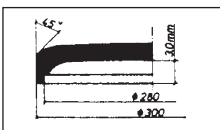

R. Pfisterer

XAC 300.563 III

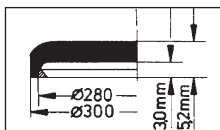

Porta E-Nautik 060165

XAG 300.614 III

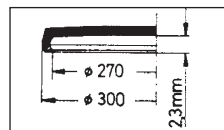

Mikado 4G 3009

XAC 300.615 III

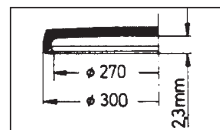

Mikado 4G 3009

XAG 301.532 III

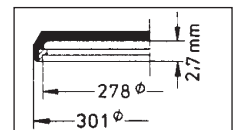

Seiko 300 T 03 ANG

XAC 301.540 III

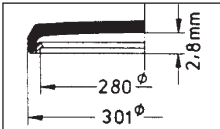

Seiko 300 T 12 ANG

XAC 301.541 III

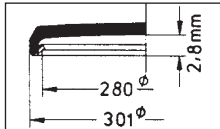

Seiko 300 T 12 ANS

XAG 301.598 III

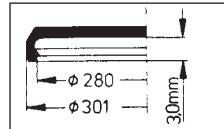

Seiko 300 T 20 ANS

XAC 301.616 III

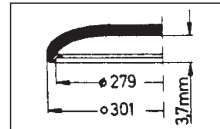

Seiko 300 T 04 ANG

XAC 301.617 III

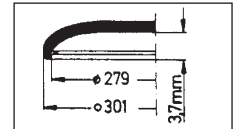

Seiko 300 T 04 ANS

XAG 301.618 III

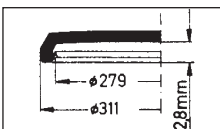

Seiko 300 T 10 ANG

XAC 301.619 III

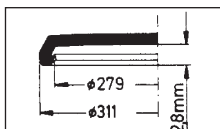

Seiko 300 T 10 ANS

XAG 301.620 III

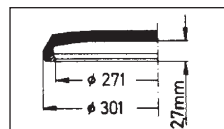

Seiko 300 T 15 ANG

XAC 301.621 III

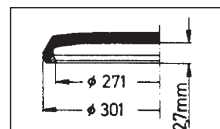

Seiko 300 T 15 ANS

XAG 301.639 III

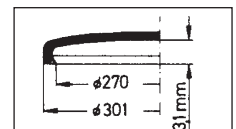

Seiko 300 T 07 ANG

# Rund-Sonderform Kunststoff armiert

## Round Special Forms Plastic Armed



XAC 301.640 III

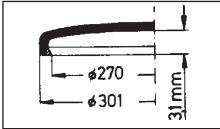

Seiko 300 T 07 ANS

XAC 301.641 III

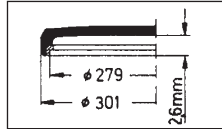

Seiko 300 T 03 ANS

XAG 301.642 III

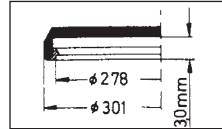

Seiko 300 T 20 ANG

XAG 301.645 III

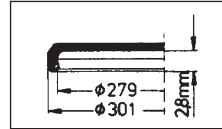

Seiko 300 T 40 ANG

XAC 301.646 III

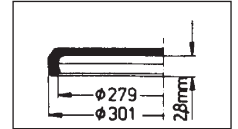

Seiko 300 T 44 ANS

XAG 301.661 III

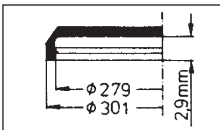

Seiko 300 T 40 ANAO

XAC 301.684 III

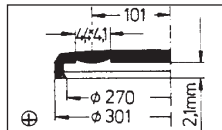

Seiko 300 T 31 ALSO

XAC 301.685 III

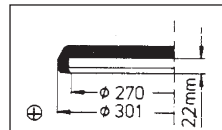

Seiko 300 T 33 AASO

XAG 301.737 III

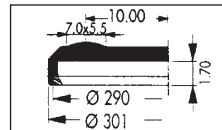

XAO-FAC 302.185 III

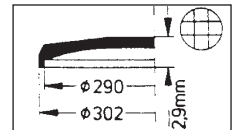

Ricoh

XAG 305.738 III

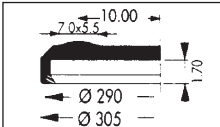

XAC 306.568 III

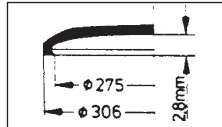

Orient OS-327 OS-345 mit Drücker, M006GA

XAC 306.605 III

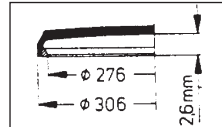

Citizen 54-0385

XAG 306.739 III

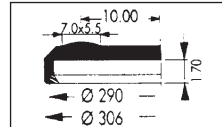

XAC 307.516 III

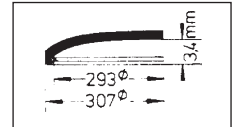

Certina 982/1 30,5-7

XAC 307.578 III

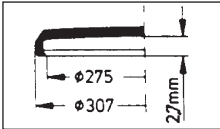

Orient 15-057

XAC 307.561 III

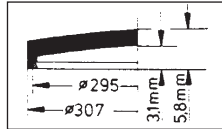

BWC 953011

XAO-FAC 310.141 III

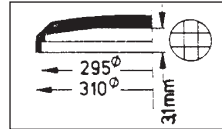

Ricoh 61.293 A

XAO-FAC 310.142 III

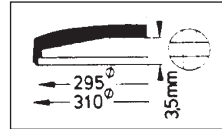

Ricoh 61.264

XAG 310.511 III

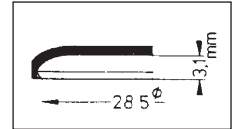

Kienzle 060 11/12

XAC 310.512 III

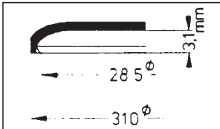

Kienzle 060 11/12

XAC 310.538 III

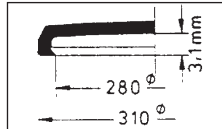

Citizen

XAC -FAC 310.539 III

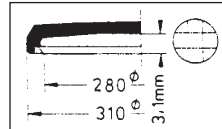

Citizen mit Dachflächen

XAC 310.583 III

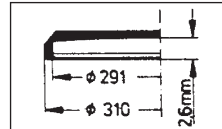

Seiko 310 T19 ANS

XAG 310.627 III

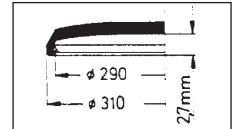

Seiko 310 T19 ANG

XAO-FAC 311.143 III

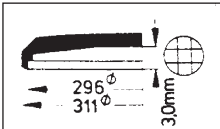

Ricoh

XAG 311.507 III

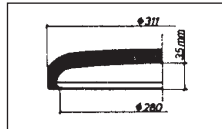

XAC 311.523 III

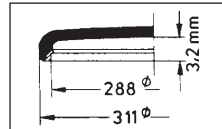

Seiko 310 T 10 ANS

XAC 311.527 III

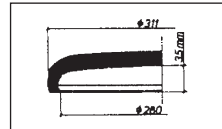

XAG 311.530 III

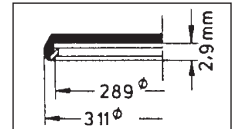

Seiko 310 T 16 ANG

XAG 310.531 III

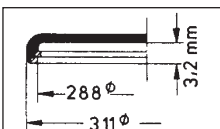

Seiko 310 T 10 ANG

XAC 311.558 III

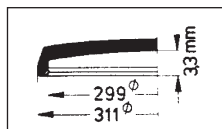

Seiko 310 T 08 ANS

XAC 311.569 III

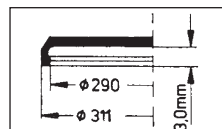

Seiko 310 T 16 ANS

XAG 311.582 III

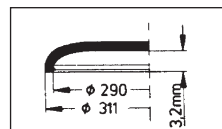

Seiko 310 T 04 ANG

XAC 311.585 III

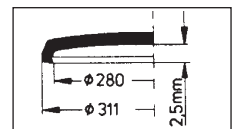

Citizen 54-03961

# Rund-Sonderform Kunststoff armiert

## Round Special Forms Plastic Armed



XAC 311.588 III

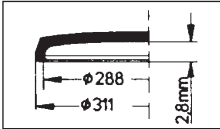

Citizen 54-03421

XAC 311.601 III

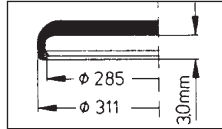

Dugena J 3747.718

XAC 311.608 III

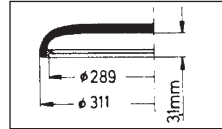

Seiko 310 T 04 ANS

XAG 311.613 III

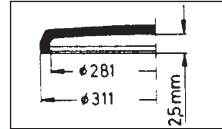

Citizen 54-3951  
Mikado4G 3010 C

XAG 311.623 III

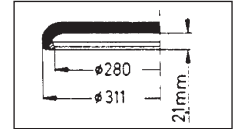

Seiko 310 T 11 ANG

XAC 311.624 III

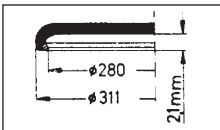

Seiko 310 T 11 ANS

XAG 311.625 III

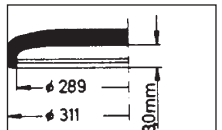

Seiko 310 T 14 ANG

XAC 311.626 III

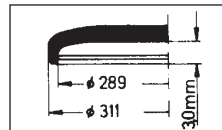

Seiko 310 T 14 ANS

XAG 311.628 III

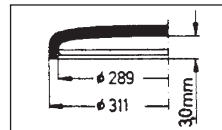

Seiko 310 T 25 ANG

XAC 311.629 III

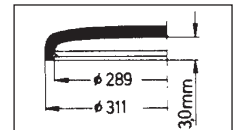

Seiko 310 T 25 ANS

XAG 311.643 III

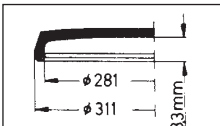

Seiko 310 T 08 ANG

XAG 311.647 III

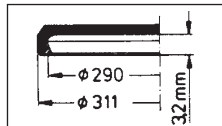

Seiko 310 T 48 ANG

XAC 311.648 III

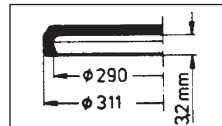

Seiko 310 T 48 ANS

XAG 311.649 III

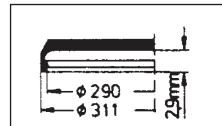

Seiko 310 T 18 ANG

XAC 311.650 III

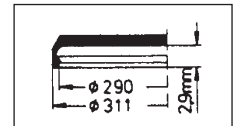

Seiko 310 T 18 ANS

XAG 311.651 III

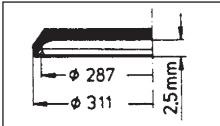

Seiko 310 T 49 ANG

XAC 311.652 III

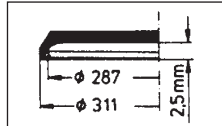

Seiko 310 T 49 ANSO

XAC 311.656 III

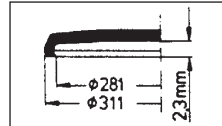

Citizen 54-05701 S

XAC 311.660 III

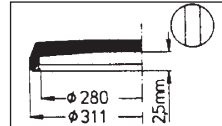

Citizen 54-05851 S

XAC 311.664 III

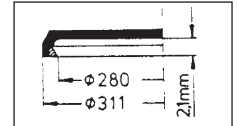

Seiko 310 T 57 ANSO

XAG 311.676 III

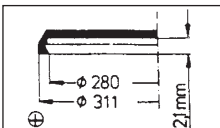

Seiko 310 T 57 ANG

XAC 311.681 III

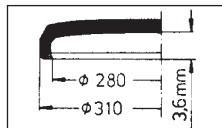

Seiko 310 T 51 ACSG

XAC 311.686 III

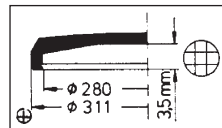

Seiko 310 T 51 ACSG

XAC 311.690 III

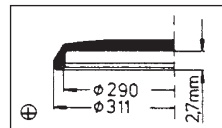

Citizen 54-05731 S

XAG 312.564 III

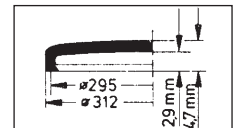

XAC 312.565 III

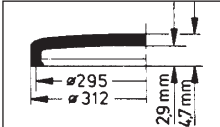

Ricoh

XAC 312.678 III

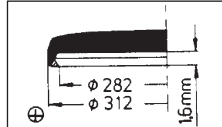

Certina 982/10

XAC 312.679 III

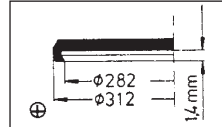

Certina 982/1

XAC 312.680 III

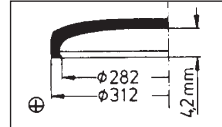

Certina 982/10

XAO-FAC 313.144 III

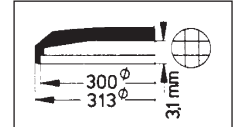

Ricoh 61.277 A

XAO-FAC 313.145 III

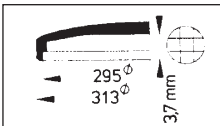

Ricoh

XAO-FAC 313.146 III

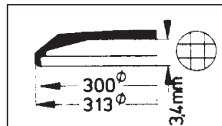

Ricoh 61.248

XAO-FAC 314.147 III

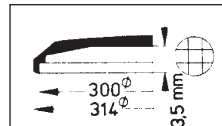

Ricoh 61.248

XAG 314.542 III

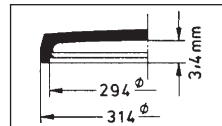

Seiko 313 T 01 ANG

XAC 314.543 III

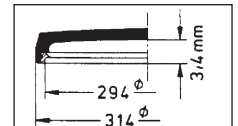

Seiko 313 T 01 ANS

# Rund-Sonderform Kunststoff armiert Round Special Forms Plastic Armed



XAG 315.500 III

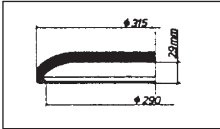

Kienzle 08/ 27.08 32/36

XAC 315.501 III

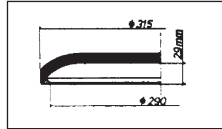

Kienzle 08/27.08 32/36

XAO-FAC 316.140 III

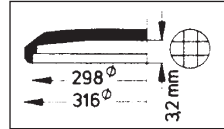

Omax

XAO\_FAC 316.148 III



Ricoh Crys 9

XAO\_FAC 316.149 III

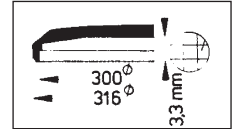

Ricoh 64.247

XAO-FAC 316.167 III

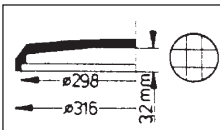

Ricoh

XAG 316.504 III

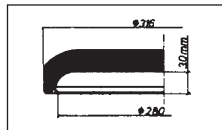

XAG 316.505 III

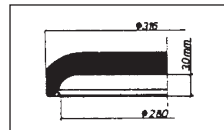

XAC 316.515 III

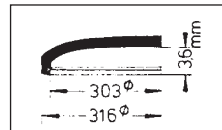

Certina 982/1 31,5-9

XAG 316.521 III

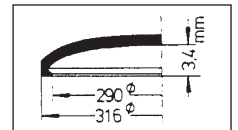

Tissot

XAC 316.522 III

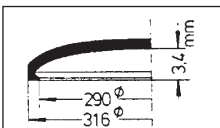

Tissot

XAC 316.524 III

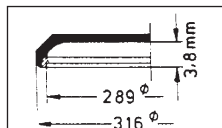

Seiko 315 T 08 ANS

XAG 316.548 III

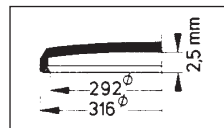

Omega 5200 und  
Tissot 10283-3

XAC 316.549 III

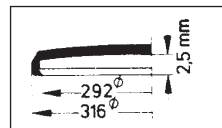

Omega 5200 und  
Tissot 10283-3

XAC 316.560 III

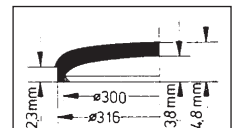

Junghans 42.756-0234  
Dugena 512 013

XAC 316.593 III

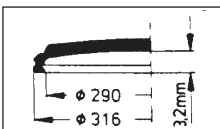

Oscro 233/13.64/581  
64/593, 64/611

XAC 316.595 III

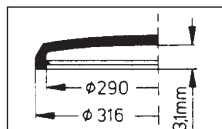

Omega 5137.5142

XAC 316.597 III

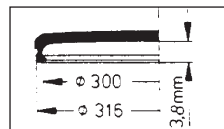

Omega 5072

XAG 316.607 III

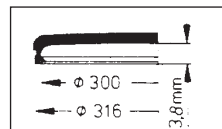

Omega 5072

XAG 316.630 III

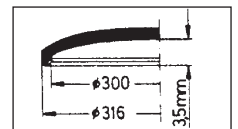

Seiko 315 T 04 ANG

XAC 316.631 III

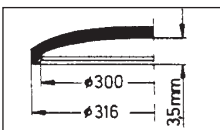

Seiko 315 T 04 ANS

XAG 316.695 III

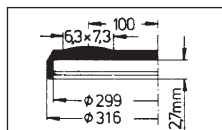

Ricoh 61.123

XAC 316.6579 III

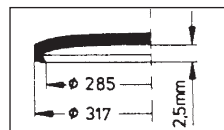

Orient 15-993

XAO-FAC 320.150 III

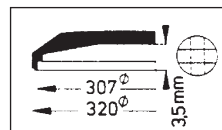

Ricoh 61.248

XAG 320.502 III



Kienzle 0862/66,1342/43

XAO-C 320.503 III

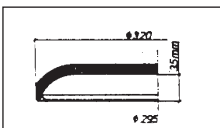

Kienzle 0862/66,1342/43

XAO-FAC 321.151 III

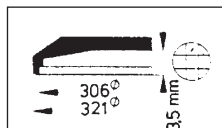

Ricoh 61.123

XAC 321.525 III

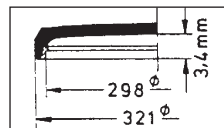

Seiko 320 T 02 ANS

XAC 321.528 III

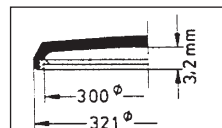

Seiko 320 T 01 ANS

XAC 321.577 III

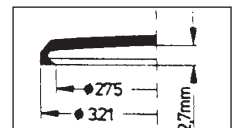

Orient 15-055

XAG 321.632 III

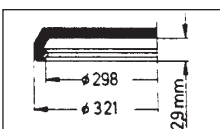

Seiko 320 T 02 ANG

XAG 321.633 III

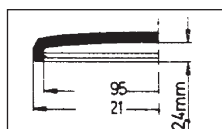

Seiko 320 T 15 ANG

XAC 321.634 III

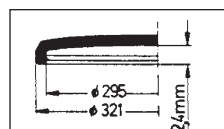

Seiko 320 T 15 ANS

XAG 321.635 III

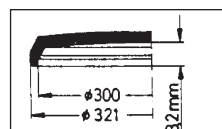

Seiko 320 T 21 ANG

XAC 321.636 III

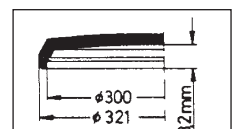

Seiko 320 T 21 ANS

# Rund-Sonderform Kunststoff armiert Round Special Forms Plastic Armed



XAG 321.637 III

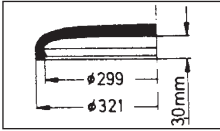

Seiko 320 T 04 ANG

XAG 321.638 III

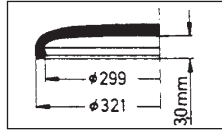

Seiko 320 T 04 ANS

XAG 321.644 III

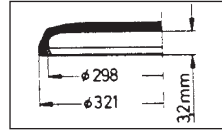

Seiko 320 T 01 ANG

XAO-FAC 322.152 III

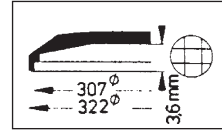

Ricoh 61,243

XAO 322.554 III

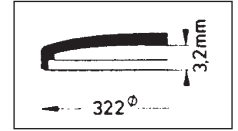

BWC 953004  
und Tissot 850

XAG 322.571 III

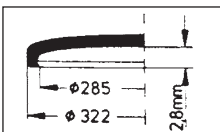

Junghans 0807

XAC 322.5712 III

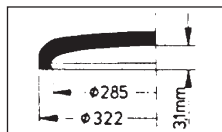

Junghans 0805

XAO-FAC 323.168 III

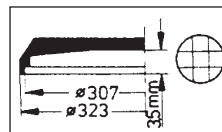

Ricoh 061123

XAO-FAC 323.169 III

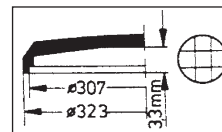

Ricoh 061248

XAO-FAC 324.153 III

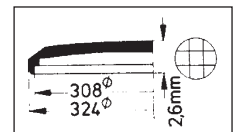

Ricoh 909

XAO-FAC 324.170 III

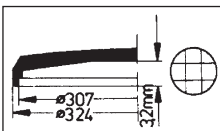

Ricoh 909-619909

XAG 324.546 III

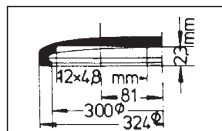

Aristo mit Langlupe

XAC 324.547 III

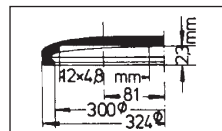

Aristo mit Langlupe

XAG 326.533 III

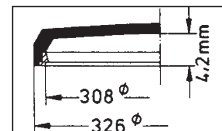

Seiko 325 T 02 ANG

XAG 326.534 III

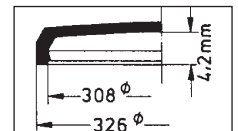

Seiko 325 T 02 ANS

XAO 327.400 III

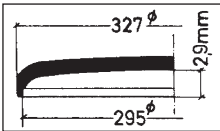

Junghans f. Minutenring

XAC 330.552 III

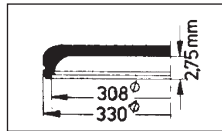

Omega 5083

XAC 330.553 III

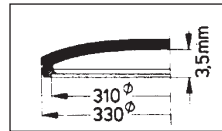

Omega 5123

XAG 330.556 III

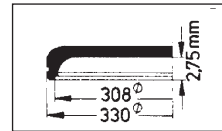

Omega 5083

XAG 330.557 III

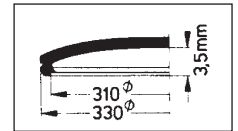

Omega 5123

XAC 330.591 III

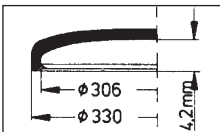

R.Pfisterer 3/2/6

XAO 332.580 III

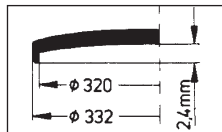

Encicar 160.71.01 o.Ring

XAO-FAC 333.171 III

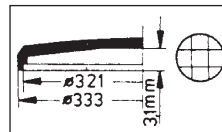

Ricoh

XAO-FAC 334.172 III

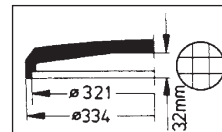

Ricoh 61202 A

XAO-FAC 335.173 III

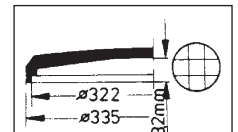

Ricoh

XAC 335.576 III

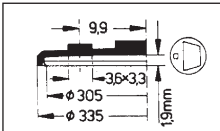

Candino

XAC 336.535 III

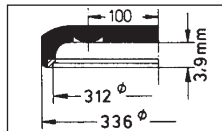

Seiko 340 T 06 ANG

XAG 341.544 III

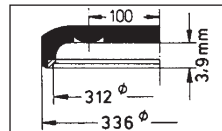

Seiko 340 T 06 ANS

XAC 341.545 III

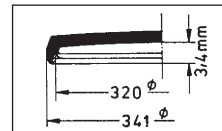

Seiko 340 T 06 ANG

XAC 341.559 III

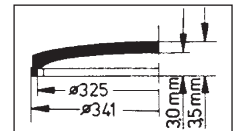

Seiko 350 T 02 ANG

XAC 342.594 III

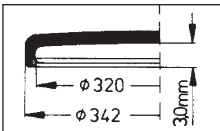

Omega Speedmaster 5077

XAC 345.562 III

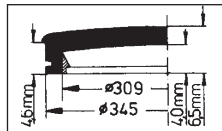

Orient 429-16240

XAC 347.698 IV

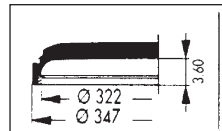

for Swatch Chrono

XAG 351.536 III

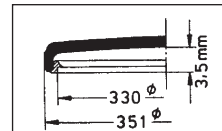

Seiko 350 T 02 ANG

XAC 351.537 III

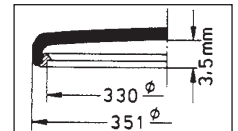

Seiko 350 T 02 ANS

# Rund-Sonderform Kunststoff armiert Round Special Forms Plastic Armed



X 358.520

IV



Aristo

XAC 387.575

III

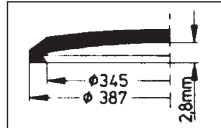

# Rund-Sonderform Kunststoff Kapselgläser Round Special Forms Plastic Capsules

»STERNKREUZ«

**XK**

**KAPSELGLAS  
CAPSULE GLASS**  
Rundglas-Sonderform  
Special form round

**Kapseln** sind Uhrgläser, die gleichzeitig ganz über das Gehäuse herüberfassen und für die Aufzugwellen oder Drücker entsprechende Bohrungen aufweisen. Sie sind immer nur für das eine Gehäuse verwendbar, für welches sie konstruiert wurden. Der Einbau geschieht in der Regel von Hand.

**Capsules** are watch glasses which reach over the sides of the case and have holes for the winder or press-button. They can only be used for the specific case they have been designed for. They are usually fitted by hand.

XK 268.300

III

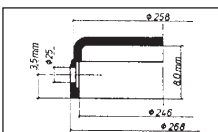

XK 298.303

III

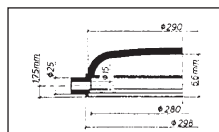

JP 2 D 2

XK 321.304

III

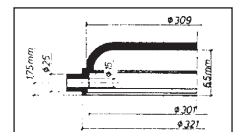

JP 2 D 4

# Rund Kunststoff – Round Plastic Unterleg – Underlaid



**»STERNKREUZ«** U

U

**UNTERLEGLAS**  
UNDERLAYED  
Rund - round

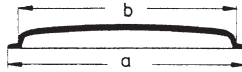

a = 1. Maß: Außendurchmesser  
b = 2. Maß: Innendurchmesser = Funktionsmaß

a = 1st measurement: outside diameter  
b = 2nd measurement: inside diameter = determining measurement

LIEFERBARE GRÖSSEN / AVAILABLE SIZES					
U 186/165	U 231/216	U 244/228	U 258/225	U 277/255	U 327/300
U 190/175	U 235/215	U 248/229	U 259/248	U 280/260	U 344/310
U 210/190	U 235/217	U 248/232	U 263/240	U 280/265	U 350/320
U 214/193	U 240/215	U 248/234	U 267/240	U 302/278	U 362/325
U 224/200	U 240/218	U 252/228	U 267/248	U 324/290	

**»STERNKREUZ«**

XU

**UNTERLEGLAS**  
UNDERLAYED  
Rundglas-Sonderform  
Special form round

Bestellnummer  
Ordering number

XU 314.201 III

Nach dem Außendurchmesser sind die Gläser geordnet.  
The Glasses are in order of their outside diameters.

Laufende Ordnungsnummer  
Current number

Preisgruppe  
Price group

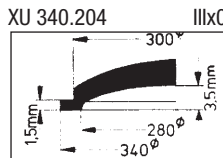
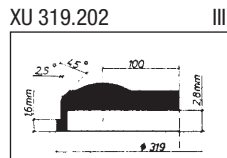
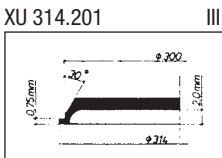
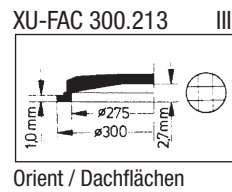
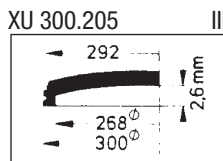
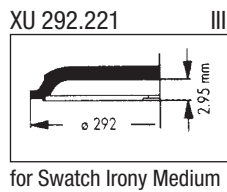

# Rund-Sonderform Kunststoff – Formproof Round Special Forms Plastic – Formproof

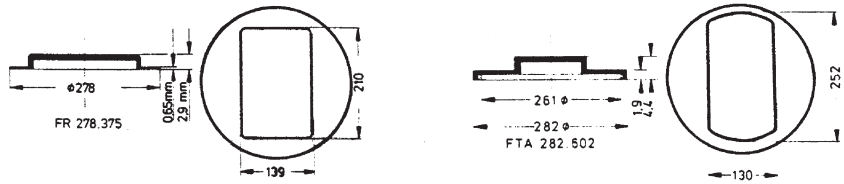

Formproof-Gläser sind runde Uhrgläser mit einem Formteil, welches aus dem Gehäuse herausragt. Diese Gläser sind noch in vielen Durchmessern mit verschiedenen Formteilen lieferbar. Bitte geben Sie uns die gewünschte Größe bekannt, und wir prüfen, ob sie im Sortiment enthalten ist.

Formproof glasses are round watch glasses with a fancy part which stands out from the case. These glasses are available in many diameters with various fancy parts. Kindly inform us of the required size and we check whether it is contained in the assortment.

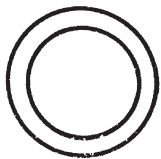

**FO** rund  
round

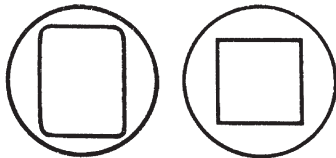

**FR** Rechteckform  
Rectangular shape

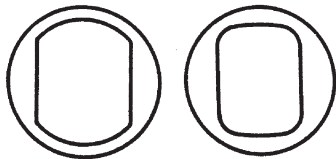

**FT** Tonnenform  
Barrel shape

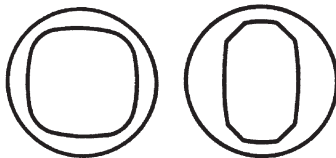

**FB** Ballenform  
Bale shape

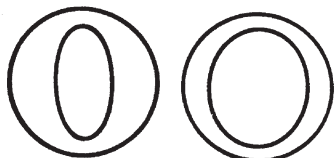

**FE** Ellipsenform  
Elliptical shape

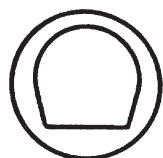

**FH** Hufeisen und sonstige Formen  
Horseshoe and other shapes



# Platten Kunststoff – Sheets Plastic



**»STERNKREUZ«**

**LCD**

**PLASTIC**  
**Uhrglasplatte**  
**Watch glass plate**  
**hart hard**

Uhrglasplatten aus ACRYLGLAS zum Selbstfräsen oder -feilen von flachen Formgläsern.  
 Watch glass plates of ACRYLGLAS for self-milling or -filing of plain fancy glasses,

LCD 42 x 42 x 0,8 mm	LCD 100 x 100 x 0,8 mm
LCD 42 x 42 x 1,0 mm	LCD 100 x 100 x 1,0 mm
LCD 42 x 42 x 1,2 mm	LCD 100 x 100 x 1,2 mm
LCD 42 x 42 x 1,5 mm	LCD 100 x 100 x 1,5 mm
LCD 42 x 42 x 1,7 mm	LCD 100 x 100 x 2,0 mm
LCD 42 x 42 x 2,0 mm	

**»STERNKREUZ«**

**YPL**

**MINEPLAN**  
**Uhrglasplatte**  
**Watch glass plate**  
**extra hart hard**

Für das Fräsen von Schablonen zum Mineralglasschleifen empfehlen wir die besonders harten Platten YPL Mineplan.

For the milling of templates for grinding mineral glass, we recommend the particularly hard plates YPL Mineplan.

YPL 42 x 42 x 1,2 mm
YPL 42 x 42 x 1,5 mm

**»STERNKREUZ«**

**LCD-VR**

**Uhrglasplatte**  
**Watch glass plate**  
**mit Maske**  
**with mask**

Bedruckte Uhrglasplatten in den Farben braun, blau und schwarz mit Fenster für LCD-Uhren, Außenmaße 42 x 42 mm. 1. Maß: Fensterbreite / 2. Maß: Fensterhöhe.

Printed watch glass plates in the colours brown, blue and black with window for LCD-watches, external dimensions 42 x 42 mm.

1. measure: width of the window opening / 2. measure: height of the window.

LCD-VR 125 x 65	LCD-VR 200 x 135	LCD-VR 240 x 80
LCD-VR 170 x 80	LCD-VR 200 x 170	LCD-VR 220 x 65 /
LCD-VR 185 x 70	LCD-VR 205 x 95	125 x 65
LCD-VR 200 x 80	LCD-VR 220x125	

Uhrglasplatten aus Kunststoff, gewölbt

PPL/G 350x300x0,6	R60
PPL/G 450x450x1,0	R60
PPL/G 450x450x1,0	R40

Uhrglasplatten rot für LED-Uhren mit roten Dioden.

Watch glass plates red for LCD-watches with red diodes.

LED 40 x 40 x 1,5 mm
LED 100 x 100 x 1,5 mm

## Form Kunststoff – Fancy Plastic

STERNKREUZ verfügt über das größte Sortiment an Kunststoff-Formgläsern, das auf der Welt existiert. Auf den nachfolgenden Seiten finden Sie die vier verschiedenen Arten, das System für Formgläser und eine Auflistung der lieferbaren Typen.

STERNKREUZ disposes of the largest assortment of plastic fancy glasses existing in the world. On the following pages you will find the four different kinds of glasses, the system for fancy glasses as well as a list of the available types.



Standard-Formgläser haben einen rohen Rand und können mit der Feile leicht auf kleinere Maße gebracht werden. Sie sind 1,0 - 1,5 mm dick.

Standard fancy glasses have got a crude border and they can easily be reduced in size with the file. They are 1,0 - 1,5 mm thick.



Konkav-Formgläser haben einen umlaufenden Fuß und können in ihren Maßen praktisch kaum noch verändert werden.

Concave fancy glasses have got a surrounding foot and their dimensions practically cannot be changed any more.



Optik-Formgläser haben eine zylindrische Oberfläche. Sie sind verhältnismäßig dick.

Optic fancy glasses have got a cylindrical surface. They are comparatively thick.



Spezial-Formgläser sind weitgehend Unterleggläser. Sie finden sie am Ende der Listen

Most of the special fancy glasses are underlaid glasses. You can find them at the end of the lists.

# Das STERNKREUZ-System für Formgläser

## The STERNKREUZ System for Fancy Glasses



Fünf Sorten Formgläser bietet das STERNKREUZ-Sortiment. Sie unterscheiden sich durch den Querschnitt und die Materialstärke. Sie sind in den Bildern dargestellt:



Standard-Formgläser - weiße Tüten in Schwarzdruck

Optik-Formgläser - weiße Tüten in Rotdruck

Konkav-Formgläser - weiße Tüten in Gründruck

Unterleg-Formgläser - weiße Tüten in Gelbdruck

Mineral-Formgläser - gelbe Tüten in Rotdruck

Häufig finden Sie eine lieferbare Abmessung in zwei verschiedenen der obigen Sorten oder auch drei. Deswegen ist es wichtig, dass Sie bei der Bestellung angeben, welche Sorte Sie wünschen.

Darüber hinaus gibt es Spezialformgläser, die jeweils nur in einer Sorte lieferbar sind. Sie sind als Unterleggläser in weißen Tüten mit Gelbdruck, als LED oder LCD-Formgläser in durchsichtigen Tüten und als Talonformgläser bzw. Platinen in weißen Tüten mit Gründruck verpackt.

Das wichtigste Unterscheidungsmerkmal für die verschiedenen Formen sind große Buchstaben. STERNKREUZ unterscheidet die folgenden:

R = Rechteckform	E = Ellipsenform
T = Tonnenform	D = Dreieckform
B = Ballenform	H = Hufeisenform
L = Laternenform	G = Geigenform

Quadratische Gläser sind in dem Buchstaben „R“ einsortiert. Man erkennt sie an den zwei gleichen Abmessungen.

Bei Formgläsern gibt es eine plane Auflage, eine zylindrisch gewölbte Auflagefläche oder eine kugelförmige. Gläser mit planer Auflage haben keine besondere Kennzeichnung. Es gelten:



Z für eine zylindrisch gewölbte Auflagefläche (zwei Seiten gewölbt)

X für eine kugelförmig gewölbte Auflagefläche (vier Seiten gewölbt)

Gläser mit schrägen oder runden Ecken oder andere Abwandlungen sind im Katalog in Grundformen einsortiert. Für die Bestellung werden sie mit kleinen Zusatzbuchstaben gekennzeichnet:

r = nach außen runde Ecken	e = gleichschenkliges Sechseck
s = schräge Ecken	a = gleichseitiges Achteck
g = gerade Flanken	y = asymmetrisch
i = nach innen runde Ecken	

Der letzte Teil der Bestellbezeichnung sind die Maße in zehntel Millimetern, jedoch abgerundet auf jeweils 0 oder 5, um nicht zu viele Maße zu erhalten.

Eine Ausnahme bilden die quadratischen Gläser R und RX. Diese beiden Sorten sind in der Ausführung "Konkav" in den Abmessungen von 140 x 140 bis 260 x 260 in allen 1/10 mm lieferbar, d. h. z. B. 140 x 140, 141 x 141, 142 x 142 usw.

Alle Formgläser sind im Katalog in Tabellenform aufgeführt. Das „X“ rechts in den Spalten zeigt jeweils, in welcher Ausführung die Gläser lieferbar sind, d.h. Standard, Optik oder Konkav.

Eine Bestellung muss folgendes enthalten: Stückzahl, Glassorte, Kennbuchstabe: Glasgröße z.B. 10 Stück Konkav T 210x230x 160.

Maße, die nicht im Katalog enthalten sind, können in vielen Fällen in Sonderanfertigung geliefert werden. Dabei ist jedoch eine entsprechende Lieferzeit zu berücksichtigen.

# Das STERNKREUZ-System für Formgläser

## The STERNKREUZ System for Fancy Glasses



Five types of fancy glasses are offered by the STERNKREUZ assortment. Their differences result from the section and the material thickness. They are presented in the illustrations:



- Standard fancy glasses - white bags in black print
- optic fancy glasses - white bags in red print
- concave fancy glasses - white bags in green print
- underlayered fancy glasses - white bags in yellow print
- mineral fancy glasses - yellow bags in red print

You will often find one available dimension in two or even three different kinds of the a. m. types. Therefore it is important that in your order you indicate which type you would like to have.

Moreover there are special fancy glasses, which are always available in one type only. They are packed as underlayered glasses in white bags with yellow print, as LED- or LCD-fancy glasses in transparent bags and as talon - glasses respectively plates in white bags with green print.

The most important characteristic to distinguish the different shapes are capital letters, STERNKREUZ make use of the following.

- |                       |                      |
|-----------------------|----------------------|
| R = Rectangular shape | E = Elliptic shape   |
| T = Barrel shape      | D = Triangular shape |
| B = Bale shape        | H = Horseshoe shape  |
| L = Latern shape      | G = Violin shape     |

Square glasses are classified in the letter "R". They are to be recognized at the two same dimensions.

Concerning fancy glasses there is a plane support, a cylindrically domed or a globularly domed support. Glasses with plane support do not have any special marks. The following is



- Z for cylindrically domed support (two sides domed)
- X for a globularly domed support (four sides domed)

Glasses with straight cut or round corners or other variations are mentioned in basic shapes in the catalogue. For your order they are marked with small additional letters:

- |                          |                         |
|--------------------------|-------------------------|
| r = round corners        | e = isoceles hexagon    |
| s = straight-cut corners | a = equilateral octogon |
| g = straight flanks      | y = asymmetrical        |
| i = convex corners       |                         |

The last part of the order designation are the dimensions in tenth millimeters, however, rounded off to 0 or 5, in order not to get too many dimensions.

An exception is made by the square glasses R and RX. These two types are available in the execution "concave" in the dimensions from 140 x 140 to 260 x 260 in every 1/10 mm, e. g. 140 x 140, 141 x 141, 142 x 142 etc.

All fancy glasses are mentioned in the catalogue in a tabular way. The "X" right in the columns show in which execution the glasses are available, i.e. standard, optic or concave.

The following should be indicated in an order: quantity, type of glass, identification letter, glass size, e.g.:  
10 pieces concave T 210 x 230 x 160.

Those measures which are not contained in the catalogue can in many cases be made in a special fabrication. But in such a case you have to take into account a corresponding delivery time.



# Rechteckform · Rectangular shape



Bestellzeichen Marks of order		Konkav	Standard	Optik	Bestellzeichen Marks of order		Konkav	Standard	Optik	Bestellzeichen Marks of order		Konkav	Standard	Optik
R	075X130			X	R	125X105	X	X		R	140X110	X	X	X
R	075X140			X	R	125X110	X	X	X	RS	140X110		X	
R	085X120			X	R	125X115	X	X	X	RZ	140X110R4		X	
R	090X090	X	X		RX	125X115R3	X			R	140X115	X		X
RX	090X090R3	X			RZ	125X115R4	X		X	RZ	140X115R3	X		
R	090X110			X	R	125X120	X			RX	140X115R4		X	
R	090X140.1			X	RS	125X120		X		R	140X120	X	X	X
R	090X140.2HOCH			X	R	125X125	X	X	X	RX	140X120R4	X		
R	095X095		X	X	RR	125X125	X			RZ	140X120R4	X		
RX	095X095R2,5	X			RX	125X125R3	X			R	140X125		X	X
R	095X120			X	RZ	125X125R5			X	RX	140X125R4	X		
R	095X145			X	RZ	125X130R5			X	RZ	140X125R4		X	
RZ	095X180R2		X		R	125X135			X	R	140X130	X		X
R	100X090			X	R	130X070		X		RX	140X130R4			X
R	100X100	X	X	X	R	130X075			X	R	140X135	X		X
RX	100X100R2,5			X	R	130X080	X			RZ	140X135R3	X		
RZ	100X100R2,5	X		X	R	130X085		X	X	RX	140X135R4	X		X
RR	100X270			X	R	130X090		X		RZ	140X135R4			X
R	105X065		X		R	130X100	X		X	R	140X140	X	X	X
RR	105X095	X			RZ	130X100R6	X			RR	140X140			X
R	105X105	X	X	X	R	130X105	X			RX	140X140R1,7	X	X	
RX	105X105R2,5	X			RXS	130X105R4	X			RX	140X140R3	X	X	
R	105X115			X	R	130X110	X	X	X	RZ	140X140R3			X
RZ	105X145R5	X			RXR	130X110R5	X			RX	140X140R5			X
R	105X150			X	R	130X115	X	X	X	RX	140X140R6	X	X	
R	110X080			X	RR	130X115	X			RZ	140X140R8	X		
R	110X090			X	RX	130X115R4	X			RS	141X131 Platine	X		
R	110X093	X			R	130X120	X	X	X	R	141X141	X		
R	110X100	X	X	X	RX	130X120R4	X			RX	141X141R3	X		
R	110X105	X			RZ	130X120R6	X	X		R	142X142	X		
R	110X110	X	X	X	R	130X125	X		X	RX	142X142R3	X		
RR	110X110	X			RZ	130X125R5			X	R	143X143	X		
RX	110X110R2,5	X		X	R	130X130		X	X	RX	143X143R3	X		
RZ	110X110R4	X			R	130X130.1	X			R	144X084	X		
RX	110X115R3			X	R	130X130.2	X			R	144X144	X		
R	110X140			X	RX	130X130R3	X	X	X	RX	144X144R3	X		
R	115X085		X		RXS	130X130R3	X			R	145X085			X
R	115X100			X	RZ	130X130R5	X		X	R	145X100			X
R	115X105	X	X		R	130X135			X	R	145X105		X	X
R	115X110	X			R	135X070		X		R	145X110	X	X	X
RR	115X110	X			R	135X085		X		RR	145X110	X		
R	115X115	X	X	X	R	135X090		X		RX	145X110R4	X		
RR	115X115			X	R	135X095		X		R	145X115	X	X	X
RS	115X115	X			R	135X100	X			RX	145X115R3	X		
RX	115X115R2,5	X			RZ	135X100R4			X	RX	145X115R4			X
RX	115X115R3	X			R	135X105	X	X		RZ	145X115R6			X
RZ	115X115R5			X	R	135X110	X			R	145X120	X		X
R	115X155			X	RX	135X110R4	X			RX	145X120R4	X		
R	120X070		X		RZ	135X110R4			X	R	145X125	X	X	X
R	120X085			X	R	135X115	X	X	X	RX	145X125R4	X		
R	120X090	X	X	X	R	135X120	X	X	X	RZ	145X125R6			X
R	120X100	X		X	RX	135X120R3			X	R	145X130	X		X
R	120X105	X		X	RX	135X120R4				RX	145X130R3	X		
RS	120X105	X			R	135X125	X			R	145X135	X		X
RX	120X105R3	X			RX	135X125R4	X			RX	145X135R3	X		X
R	120X110	X	X	X	R	135X130	X		X	RZ	145X135R6			X
RX	120X110R2,5			X	RX	135X130R3			X	R	145X140	X		X
R	120X115	X	X	X	RX	135X130R4	X			RZ	145X140R15			X
R	120X120	X	X	X	R	135X135	X	X	X	RX	145X140R3			X
RS	120X120	X			RR	135X135			X	RZ	145X140R3			X
RX	120X120R2,5			X	RX	135X135R3			X	R	145X145	X	X	
RX	120X120R3	X		X	RZ	135X135R3	X			RX	145X145R3	X		X
RZ	120X120R5	X		X	RZ	135X135R4			X	RZ	145X145R3			X
R	120X145			X	RX	135X135R5		X		RX	145X145R6	X		X
RZ	120X145R2	X			RX	135X135R6	X		X	RZ	145X145R6			X
RZ	120X150R4	X			RR	136X136	X			R	145X150			X
RZ	120X175R4	X			R	140X075			X	R	146X146	X		
RR	121X121	X			R	140X080	X	X		RX	146X146R3	X		
R	124X124	X			R	140X090	X	X		RS	147X123 Talon	X		
R	125X065	X			R	140X095			X	R	147X147	X		
R	125X075			X	RS	140X095		X		RX	147X147R3	X		
R	125X085			X	R	140X100	X		X	R	148X148	X		
R	125X100	X	X	X	R	140X105	X		X	RX	148X148R3	X		



# Rechteckform · Rectangular shape



Bestellzeichen Marks of order		Konkav	Standard	Optik	Bestellzeichen Marks of order		Konkav	Standard	Optik	Bestellzeichen Marks of order		Konkav	Standard	Optik
R	149X149	X			RX	155X155R4	X			RR	165X132	X		
RX	149X149R3	X			RZ	155X155R4	X		X	R	165X135	X		X
RR	149X239 LCD	X			RX	155X155R5		X		RX	165X135R4		X	X
R	150X080	X	X		RXR	155X155R5	X			R	165X140	X		
R	150X090		X		R	156X156	X			R	165X145			X
R	150X095		X	X	RX	156X156R3	X			R	165X155			X
R	150X100	X	X	X	RR	157X154	X			R	165X165	X		X
RZ	150X100R6			X	R	157X157	X			RX	165X165R4	X		
R	150X105		X		RX	157X157R3	X			RZ	165X165R6	X		
R	150X110	X	X	X	R	158X158	X			RR	166X120	X		
RS	150X110		X		RX	158X158R4	X			R	166X166	X		
R	150X115	X		X	R	159X159	X			RX	166X166R4	X		
R	150X120	X	X	X	RS	159X159	X			R	167X167	X		
RX	150X120R4			X	RX	159X159R4	X			RX	167X167R4	X		
RZ	150X120R6	X		X	R	160X070		X		R	168X168	X		
R	150X125	X	X	X	R	160X080		X		RX	168X168R4	X		
RX	150X125R4	X			R	160X085		X		R	169X169	X		
RZ	150X125R6	X			R	160X090	X	X		RX	169X169R4	X		
R	150X130	X	X	X	R	160X095			X	R	170X070		X	X
RX	150X130R4	X			R	160X100		X		R	170X085		X	X
RZ	150X130R6	X		X	R	160X105			X	R	170X090		X	
R	150X135			X	R	160X110	X	X	X	R	170X095			X
RX	150X135R4	X			RR	160X110	X			R	170X100	X	X	X
R	150X140	X	X		R	160X115	X		X	R	170X105	X	X	X
RX	150X140R3			X	R	160X120	X	X	X	RZ	170X105R4		X	
R	150X145	X		X	RS	160X120		X		R	170X110		X	
RZ	150X145R6			X	RX	160X120R4			X	R	170X115		X	
R	150X150	X	X	X	RZ	160X120R4	X			R	170X120	X		X
RA	150X150	X			R	160X125	X		X	R	170X130	X		X
RR	150X150		X	X	RX	160X125R4	X			R	170X135			X
RX	150X150R3	X	X	X	RZ	160X125R4	X		X	RZ	170X135R4	X		
RX	150X150R6	X			R	160X130	X	X	X	R	170X140			X
RZ	150X150R8	X		X	RX	160X130R4	X		X	RX	170X140R4	X		
R	151X151	X			RZ	160X130R4	X		X	RXS	170X145R4	X		
RR	151X151	X			R	160X135			X	RXR	170X145R5	X		
RX	151X151R3	X			RZR	160X135R8	X		X	R	170X150	X	X	
R	152X152	X			R	160X140	X	X		R	170X150 EXTR.FL.	X		
RX	152X152R3	X			RX	160X140R5	X		X	RXR	170X150R4	X		
R	153X153	X			R	160X145	X		X	R	170X155	X		
RX	153X153R3	X			RZ	160X145R8	X		X	RX	170X155R4	X		
R	154X154	X			R	160X150	X	X	X	RX	170X160R4	X	X	
RX	154X154R3	X			RX	160X150R5	X		X	RXR	170X160R4	X		
R	155X070		X		RX	160X150R6	X			R	170X165		X	
R	155X080	X			RZ	160X150R8	X		X	R	170X170	X	X	X
R	155X100			X	R	160X155			X	RA	170X170		X	
R	155X105	X	X		R	160X160	X	X	X	RR	170X170	X		
RX	155X105R4	X			RR	160X160	X			RX	170X170R1.5		X	
R	155X110	X	X	X	RX	160X160R3	X			RX	170X170R4	X		X
RX	155X110R4	X			RX	160X160R4	X		X	RX	170X170R5,0		X	
R	155X115		X		RZ	160X160R4	X			RZ	170X170R6	X		
RS	155X115		X		RX	160X160R5		X		RR	171X145 Platine	X		
RX	155X115R4			X	R	161X161	X			R	171X171	X		
R	155X120	X		X	RX	161X161R4	X			RX	171X171R4	X		
RX	155X120R3	X			R	162X162	X			R	172X172	X		
RXR	155X120R3	X			RS	162X162 Platine/Talon	X		X	RX	172X172R4	X		
RX	155X120R4	X			RX	162X162R4	X			R	173X143	X		
RZ	155X120R6	X		X	R	163X163	X			R	173X173	X		
R	155X125	X		X	RX	163X163R4	X			RX	173X173R4	X		
RX	155X125R4			X	R	164X164	X			R	174X174	X		
RZ	155X125R4			X	RX	164X164R4	X			RX	174X174R4	X		
RX	155X125R6			X	R	165X080	X		X	R	175X090		X	
RZ	155X125R6	X			R	165X090	X		X	R	175X095		X	
R	155X130			X	R	165X100	X	X		RZ	175X100R6		X	
R	155X135			X	RS	165X100	X	X		R	175X105	X		X
RA	155X135	X			RZ	165X100R8		X		RS	175X105	X	X	
R	155X140	X		X	R	165X115			X	R	175X110	X	X	
RZ	155X140R6			X	R	165X120			X	RI	175X110		X	
R	155X145	X		X	RX	165X120R4				RR	175X110		X	
RZ	155X145R6	X		X	R	165X125	X		X	RX	175X115R6			X
R	155X155	X	X	X	RX	165X125R4			X	RX	175X120R6	X	X	X
RR	155X155	X			RX	165X130R4	X			R	175X125	X		
RX	155X155R3	X		X	RXR	165X130R4	X			RZ	175X125R4	X		



# Rechteckform · Rectangular shape



Bestellzeichen Marks of order		Konkav	Standard	Optik	Bestellzeichen Marks of order		Konkav	Standard	Optik	Bestellzeichen Marks of order		Konkav	Standard	Optik
R	175X130	X		X	R	185X165	X			RS	197X153 Platine	X		
R	175X135		X		RZ	185X165R5		X		R	197X197	X		
RZR	175X135R4			X	RZ	185X180R6			X	RX	197X197R5	X		
R	175X145		X	X	R	185X185	X	X	X	R	198X198	X		
R	175X150	X		X	RR	185X185	X		X	RX	198X198R5	X		
RZ	175X150R4	X			RX	185X185R4	X			R	199X199	X		
RX	175X155R4	X			RXR	185X185R4	X			RX	199X199R5	X		
RZ	175X155R4	X	X	X	RZ	185X185R6	X			R	200X100		X	
R	175X175	X	X	X	R	186X138	X			RZ	200X110R5		X	
RX	175X175R4	X			RR	186X140 Talon	X			R	200X120	X	X	
RZ	175X175R6	X			R	186X186	X			R	200X125	X		
RZ	175X220-8 DACHFORM		X		RX	186X186R4	X			RS	200X125 Platine	X		
RZ	175X250R4			X	RR	187X147	X			RZ	200X125R9	X	X	
R	176X176	X			R	187X187	X			R	200X130	X	X	
RX	176X176R4	X			RX	187X187R4	X			RS	200X130		X	
RS	177X154 Platine	X			R	188X188	X			RS	200X135		X	
R	177X177	X			RX	188X188R5	X			R	200X140	X		
RS	177X177 Platine	X			RR	189X148	X			R	200X150		X	
RX	177X177R4	X			R	189X189	X			R	200X155		X	X
RS	178X155 Platine	X			RX	189X189R5	X			RR	200X157	X		
R	178X178	X			R	190X080		X		R	200X165	X	X	
RX	178X178R4	X			R	190X100			X	RZ	200X170R6	X		
R	179X179	X			RS	190X100		X		R	200X175	X		X
RR	179X179	X			R	190X120		X		RX	200X175R4	X	X	
RX	179X179R4	X			RZ	190X120R3	X			RX	200X175R5			X
RR	179X219 LCD	X			R	190X125	X			RZ	200X175R5		X	
R	180X090			X	R	190X135	X			RX	200X175R6	X		
R	180X110	X	X		RR	190X135	X			R	200X180	X		
RS	180X110		X		R	190X140	X		X	RR	200X180	X		
RZ	180X110R4	X			RR	190X142	X			RZ	200X180R6			X
R	180X120	X	X	X	R	190X145	X			RZ	200X185R6			X
R	180X125	X			RR	190X155	X			R	200X190		X	
R	180X130		X	X	RZR	190X155R10	X			RZ	200X190R10	X		
RZ	180X130R5		X		RXR	190X155R5	X			RZ	200X190R6			X
R	180X135	X			R	190X160	X			RZ	200X195R10	X		
R	180X140			X	R	190X180	X		X	R	200X200	X	X	X
RR	180X140	X			R	190X190	X	X	X	RA	200X200		X	
R	180X150	X	X	X	RS	190X190	X	X		RS	200X200		X	
RX	180X155R4	X		X	RX	190X190R5	X	X	X	RZ	200X200R10		X	
R	180X165	X	X	X	RZ	190X190R6	X		X	RX	200X200R6	X	X	
RX	180X165R4	X			RZ	190X225R7		X		RR	201X154	X		
R	180X180	X	X	X	R	191X191	X			RR	201X171 Talon	X		
RA	180X180	X			RX	191X191R5	X			RS	201X181	X		
RR	180X180	X		X	R	192X192	X			R	201X201	X		
RS	180X180	X			RX	192X192R5	X			RX	201X201R6	X		
RX	180X180R4	X	X	X	R	193X193	X			RR	202X151	X		
RZ	180X180R6	X		X	RX	193X193R5	X			R	202X202	X		
RR	181X100 Platine	X			R	194X194	X			RX	202X202R6	X		
R	181X181	X			RX	194X194R5	X			RX	203X203R5	X		
RX	181X181R4	X			RZ	195X115R3			X	R	204X204	X		
R	182X182	X			R	195X120	X			RX	204X204R5	X		
RX	182X182R4	X			R	195X125	X	X	X	RZ	205X090R5	X		
R	183X183	X			RX	195X125R5	X			RZ	205X105R7		X	
RX	183X183R4	X			R	195X130	X			R	205X130		X	
R	184X184	X			R	195X135			X	RX	205X130	X		
RX	184X184R4	X			RS	195X140		X		RZ	205X135R4	X		
R	185X085		X		RZ	195X150R3			X	RZ	205X135R9		X	
R	185X095		X		RX	195X155R5		X		R	205X170		X	
R	185X110		X		R	195X165			X	R	205X175	X		
R	185X115	X	X	X	R	195X175	X			R	205X180	X	X	
RZ	185X115R10	X			RZ	195X180R10	X			RZ	205X180R10		X	
R	185X120	X		X	R	195X185	X		X	RXR	205X180R6	X		
RZ	185X120R3	X			R	195X195	X			RZ	205X180R6			X
RZ	185X120R8	X			RR	195X195	X			RZR	205X180R6	X		
R	185X125	X			RS	195X195 Platine	X			R	205X185		X	
RR	185X135			X	RX	195X195R5	X	X	X	R	205X190		X	
R	185X140		X		RZ	195X195R6	X		X	RX	205X190R5	X		
R	185X150	X			RZ	195X215R5,5	X		X	RX	205X190R5 DACHFORM		X	
RX	185X150R4	X			RZ	195X225R4			X	R	205X200			X
R	185X155	X			R	196X196	X			RZ	205X200R10			X
RX	185X155R5			X	RX	196X196R5	X			R	205X205	X	X	X
RX	185X160R5	X			R	197X146	X			R	205X205 DACHFORM	X	X	



# Rechteckform · Rectangular shape



Bestellzeichen Marks of order	Konkav	Standard	Optik	Bestellzeichen Marks of order	Konkav	Standard	Optik	Bestellzeichen Marks of order	Konkav	Standard	Optik
RZ 205X205R10			X	R 215X160		X	X	R 221X221	X		
RX 205X205R5	X			RZ 215X160R6		X		RX 221X221R5	X		
RZ 205X205R5		X		RR 215X165	X			RR 222X133	X		
RZ 205X205XR10	X			RX 215X165R5	X			R 222X222	X		
RZ 205X225R12	X			R 215X170	X	X	X	RX 222X222R5	X		
R 206X206	X			RR 215X170	X			R 223X223	X		
RX 206X206R5	X			R 215X175			X	RX 223X223R6	X		
RR 207X156 Platine	X			R 215X175 DACHFORM		X		R 224X224	X		
RR 207X167	X			R 215X180		X		RX 224X224R6	X		
R 207X207	X			RS 215X180	X			R 225X110		X	
RX 207X207R5	X			R 215X185			X	R 225X125		X	
RS 208X165	X			RZ 215X185R6	X	X	X	RI 225X130		X	
R 208X208	X			R 215X190	X	X	X	RZ 225X135R8		X	
RX 208X208R5	X			RZ 215X190R6			X	R 225X150		X	
R 209X082	X			R 215X195	X			RZ 225X150R10		X	
RS 209X131 Platine	X			RX 215X195R4 DACHFORM		X		RZ 225X150R5			X
R 209X209	X			R 215X200			X	R 225X155		X	X
RX 209X209R5	X			RX 215X200R5			X	RZ 225X155R15	X	X	X
R 210X100			X	R 215X210			X	RX 225X155R5			X
R 210X105	X			RZ 215X210X8			X	RS 225X160		X	
R 210X110	X			R 215X215	X	X	X	RZ 225X160R8		X	
R 210X140		X	X	RA 215X215	X			R 225X165		X	
RZ 210X140R7		X		RS 215X215		X		R 225X170	X		
R 210X150	X			R 215X215.2	X			RZ 225X170R10		X	
RS 210X150	X			RX 215X215R5	X			RZ 225X170R8	X		
R 210X160	X	X		RX 215X215R5 DACHFORM		X		R 225X175	X	X	X
R 210X170	X	X		RZ 215X215R8	X		X	RR 225X175		X	
RX 210X170R5			X	R 215X220			X	R 225X180		X	
RZ 210X170R6	X			RS 216X096	X			RS 225X180		X	
R 210X175	X			RS 216X169 Platine	X			RZ 225X180R8	X		
RX 210X175R5			X	R 216X216	X			R 225X185	X		X
R 210X180	X	X	X	RX 216X216R5	X			RX 225X185R5	X		X
R 210X180.2 EXTR.FL	X			R 217X217	X			R 225X190	X	X	
RX 210X180R5			X	RX 217X217R5	X			RZ 225X190R8	X		
R 210X185			X	R 218X086	X			RX 225X195R5	X		X
RX 210X185R5			X	RX 218X218R5	X			RX 225X195R5 DACHFORM	X		
R 210X190	X		X	R 219X219	X			RZ 225X195R8	X		
RX 210X190R5	X			RS 219X219	X			R 225X200	X		X
R 210X195	X	X	X	RX 219X219R5	X			RZ 225X200R8	X		
RR 210X195			X	R 220X090	X			R 225X205			X
RZ 210X195R6	X		X	R 220X120		X		RZ 225X205R8	X		
R 210X200	X	X	X	R 220X125		X		R 225X210	X	X	X
RR 210X200	X		X	RR 220X130	X			RZ 225X210R8	X		
RX 210X200R5	X			RR 220X140	X			R 225X215			X
RZ 210X200R6	X			R 220X145	X		X	RR 225X215	X		
R 210X205	X	X		R 220X150		X	X	RZ 225X215R10		X	
R 210X210	X	X	X	R 220X155		X		RX 225X215R5		X	
RS 210X210	X	X		RZ 220X155R6		X		R 225X220			X
RX 210X210R5	X	X	X	R 220X160			X	RR 225X220			X
R 210X215			X	R 220X165		X		RZR 225X220R5			X
RR 211X171 Platine	X			RZ 220X165R10		X		R 225X225	X	X	X
R 211X178 Talon	X			R 220X170	X		X	RR 225X225		X	
R 211X211	X			RZ 220X170	X			RS 225X225		X	
RX 211X211R5	X			RZ 220X170R6		X		RX 225X225R5	X		X
R 212X212	X			R 220X175	X	X	X	RZ 225X225R5		X	X
RX 212X212R5	X			R 220X180	X	X	X	RZR 225X225R5			X
R 213X101 Platine	X			RZ 220X180R5		X		RX 225X225R5 DACHFORM	X		
RS 213X160	X			R 220X190	X		X	RX 225X225R6		X	
RR 213X183 Talon	X			RX 220X190R5	X	X	X	R 226X226	X		
R 213X213	X			R 220X195		X	X	RX 226X226R6	X		
RX 213X213R5	X			RR 220X195	X		X	R 227X189	X		
R 214X214	X			R 220X200	X		X	R 227X227	X		
RX 214X214R5	X			R 220X200EXTRA FL	X			RX 227X227R6	X		
R 215X090		X		RX 220X200R5	X			RS 228X209	X		
RS 215X105		X		RZ 220X200R8	X			R 228X228	X		
RS 215X120		X		R 220X215		X		RX 228X228R6	X		
RZR 215X135R10		X		R 220X220	X	X	X	RZR 229X159X7,5	X		
R 215X140		X		RX 220X220R10	X	X	X	R 229X229	X		
R 215X145		X		RX 220X220R3,5		X		RX 229X229R6	X		
R 215X150	X	X		RX 220X220R5	X			RS 230X125		X	
RZ 215X150R18		X		RZ 220X220R8		X		RS 230X130		X	
RX 215X155R5			X	R 220X225		X	X	RZ 230X140R5		X	





# Rechteckform · Rectangular shape



Bestellzeichen Marks of order		Konkav	Standard	Optik	Bestellzeichen Marks of order		Konkav	Standard	Optik	Bestellzeichen Marks of order		Konkav	Standard	Optik
RZ	230X140R6			X	R	235X215			X	R	245X165		X	X
RZ	230X145R5		X		R	235X225	X			RX	245X165R5	X	X	
RZ	230X150R8	X			RZ	235X225R8		X		R	245X170	X		
R	230X155	X			R	235X230	X		X	RR	245X170		X	
R	230X160	X	X	X	RX	235X230R5	X			RZ	245X170R6		X	
R	230X165		X		RXR	235X230R5	X			RZ	245X175R8	X		
RZ	230X165R5		X		RZ	235X230R8			X	RX	245X180R6			X
R	230X170		X	X	R	235X235	X		X	RZ	245X185R8	X		
RZ	230X170R12		X		RX	235X235R5	X		X	R	245X190	X	X	
RX	230X170R5			X	RX	235X235R5 DACHFORM		X		RR	245X190	X		
RZ	230X170R5			X	RZ	235X235R8			X	RS	245X190	X		
RZ	230X170R6		X		R	236X236	X			RX	245X190R5	X		
R	230X175	X	X		RX	236X236R5	X			RX	245X190R6			X
RR	230X175		X		R	237X237 Talon	X			RZ	245X190R9		X	
RX	230X175R5			X	RX	237X237R5	X			RR	245X195	X		
RZ	230X175R5		X	X	R	238X238	X			RZ	245X195R10		X	
R	230X180	X		X	RX	238X238R5	X			RZ	245X200R8	X		
RX	230X180R5		X	X	R	239X075 Platine	X			R	245X210	X		X
RZ	230X180R5			X	R	239X239	X			RZ	245X215R8	X		
R	230X185	X	X	X	RR	239X239 LED	X			R	245X220			X
RZ	230X185R10		X		RX	239X239R5	X			RZ	245X220R8	X		
RZ	230X185R15			X	R	240X130		X		R	245X235EXTR.FL.	X		
RX	230X185R5			X	R	240X150		X		R	245X245	X		X
RZ	230X185R5		X	X	RS	240X150	X			RS	245X245	X		
R	230X190			X	RZ	240X150R4		X		RXCL	245X245-75	X		
RX	230X190R3,5		X	X	RX	240X155R5	X			RX	245X245R5	X	X	X
R	230X195		X		RZ	240X155R8	X			R	246X246	X		
RR	230X195	X			R	240X160		X		RX	246X246R5	X		
R	230X200			X	RZ	240X160R10		X		R	247X247	X		
RX	230X200R5		X		RZ	240X165R10		X		RX	247X247R5	X		
RX	230X205R5	X		X	RZ	240X165R6		X		R	248X248	X		
R	230X210	X	X		R	240X170		X	X	RX	248X248R6	X		
RZ	230X210R8	X			R	240X175	X		X	R	249X249	X		
R	230X215			X	RZ	240X175R10		X		RX	249X249R6	X		
RX	230X215R4			X	RZ	240X175R7		X		RZ	250X140R5		X	
R	230X225			X	R	240X180	X		X	RX	250X150R5			X
R	230X230	X	X	X	RX	240X180R6	X			RZ	250X150R8			X
RX	230X230R12,5	X			R	240X185	X	X		R	250X155		X	
RX	230X230R3,5	X	X		RZ	240X185R10		X		RZ	250X155R8	X	X	
RX	230X230R5	X	X	X	RX	240X185R6			X	R	250X160	X		
RZ	230X230R5			X	R	240X190			X	RR	250X160.1	X		
RZ	230X230R8	X			R	240X200		X	X	RR	250X160.2	X		
R	231X231	X			RX	240X200R5		X	X	RZ	250X160R10		X	
RX	231X231R6	X			RR	240X205			X	RZ	250X160R8	X		
R	232X232	X			R	240X210	X			R	250X165		X	
RX	232X232R6	X			RZ	240X210R8		X	X	RZ	250X165R10		X	
R	233X233	X			R	240X215			X	R	250X170	X		
RX	233X233R5	X			RX	240X220R6		X		RZ	250X170R15		X	
R	234X234	X			RX	240X235R5	X			RZ	250X170R8	X	X	
RX	234X234R5	X			R	240X240	X	X	X	R	250X175		X	
RZ	235X125R7		X		RS	240X240	X			RZ	250X175R6		X	
R	235X135		X		RX	240X240R3,5		X		RZ	250X175R8	X		
R	235X150	X			RXR	240X240R3,5	X			R	250X180	X	X	
RZ	235X150R6		X		RX	240X240R5	X	X	X	RS	250X180	X	X	
R	235X155	X			RXR	240X240R5	X			RZ	250X180R10		X	
RZ	235X155R6		X		RZ	240X240R8		X		RZ	250X180R8			X
R	235X165			X	R	241X241	X			R	250X185	X		
RZ	235X165R7		X		RX	241X241R5	X			RZ	250X185R8		X	
R	235X175	X	X		RR	242X202 Talon/O-Ring		X		R	250X190	X		
R	235X180	X			R	242X242	X			RZ	250X190R10		X	
RR	235X180		X		RX	242X242R5	X			RX	250X190R3,5		X	X
RZ	235X180R6		X		R	243X243	X			RX	250X190R5	X		
R	235X185		X	X	RR	243X243 Talon	X			R	250X195	X		
R	235X195			X	RX	243X243R5	X			R	250X200	X	X	
RZ	235X195R8			X	R	244X244	X			RZ	250X200R8		X	
RZ	235X195R9		X		RX	244X244R5	X			R	250X210			X
R	235X200	X	X		RS	245X140		X		RX	250X210R6			X
RR	235X200	X		X	RS	245X145	X			RZ	250X215R8		X	
RZR	235X200R15			X	RZ	245X150R5		X		R	250X230		X	X
RX	235X205R5			X	RZ	245X150R8	X			R	250X230EXTR.FL.	X		
RZ	235X205R8		X		R	245X160	X	X	X	RZ	250X230R6	X		X
R	235X210			X	RZ	245X160R7	X	X		RZ	250X235R8		X	



# Rechteckform · Rectangular shape



Bestellzeichen Marks of order		Konkav	Standard	Optik	Bestellzeichen Marks of order		Konkav	Standard	Optik	Bestellzeichen Marks of order		Konkav	Standard	Optik
R	250X250	X	X		R	260X210	X			RXCL	270X270-95	X		
RS	250X250	X	X		R	260X220	X	X	X	RX	270X270R3,0		X	
R	250X250EXTRA FL	X			R	260X230	X	X	X	RX	270X270R4,0		X	
RX	250X250R5		X		RX	260X230R6	X	X	X	RXR	270X270R5	X		
RX	250X250R6	X			R	260X240			X	RX	270X270R6	X		X
RZ	250X250R8		X		R	260X260	X	X	X	RX	270X270R8		X	
RR	251X221	X			RX	260X260R5	X			RZ	270X270R9		X	
R	251X251	X			RX	260X260R6		X		RZR	273X154	X		
RX	251X251R6	X			RXR	260X260R6	X			R	275X101	X		
R	252X252	X			RX	260X260R8	X			R	275X160		X	
RX	252X252R6	X			RZ	260X260R9		X		RZ	275X160R10		X	
R	253X253	X			RXCL	260X260RE-95	X			R	275X175	X		
RX	253X253R6	X			RS	262X260 Platine	X			RZ	275X175R8		X	
R	254X254	X			R	265X120	X			RZ	275X180		X	
RX	254X254R6	X			RR	265X120	X			RZ	275X180R8 DACHFORM		X	
R	255X125			X	RZ	265X175R6		X		R	275X185	X		
RZ	255X135R8		X		RZ	265X175R8			X	RZ	275X185R10		X	
R	255X155		X	X	R	265X185	X	X		RZ	275X185R7		X	
RX	255X155R5			X	RX	265X185R5 DACHFORM		X		RZ	275X185R8		X	
R	255X160	X			R	265X190		X		R	275X190			X
RR	255X170		X		RZ	265X190R10		X		R	275X195	X	X	
RZ	255X170R10		X		RX	265X190R6	X			RX	275X195R5			X
R	255X175	X			RZ	265X190R8	X			RZ	275X195R8	X		
RZ	255X185R20		X		RZ	265X195R10		X		R	275X200	X		
R	255X190	X			RZ	265X200R8	X			RZ	275X200R8	X	X	X
RZ	255X190R5		X		R	265X205	X			RZ	275X205R8	X		
RZR	255X190R5		X		RZ	265X205R6		X		RS	275X235		X	
R	255X195	X	X	X	R	265X210			X	R	275X236	X		
RZ	255X195R10		X		R	265X250	X		X	RR	275X246	X		
R	255X200		X		R	265X265	X	X		R	275X275	X	X	
R	255X205	X	X		RR	265X265	X			RX	275X275R6	X	X	
R	255X210		X		RXCL	265X265-100R8	X			RZR	277X157	X		
RZ	255X220R10			X	RXRL	265X265-70	X			R	280X140		X	
RX	255X220R6	X			RX	265X265R5	X			RZ	280X155R8		X	
R	255X225		X		RXR	265X265R5	X			R	280X160		X	
R	255X255	X	X	X	RX	265X265R6	X	X	X	RS	280X160	X		
RR	255X255		X	X	RR	266X148	X			RZ	280X170R8			X
RXR	255X255R4	X			R	267X251	X			RZ	280X175R6		X	
RX	255X255R5		X		RR	268X202	X			RZR	280X175R6		X	
RX	255X255R6	X			RZ	269X130	X			R	280X180		X	X
RX	255X255R8	X			RZR	270X125	X			RZ	280X180R8	X		
R	256X256	X			RZ	270X131	X			RZ	280X190R6		X	
RX	256X256R6	X			R	270X175		X		R	280X200	X		
R	257X127	X			RR	270X175	X			RZ	280X200R9		X	
R	257X257	X			R	270X180		X		R	280X210		X	
RX	257X257R6	X			RR	270X180	X			RX	280X210R3,5		X	
R	258X258	X			RZ	270X180R8			X	RZR	280X210R6		X	
RX	258X258R5	X			RZR	270X180R8	X			R	280X235	X	X	
R	259X259	X			R	270X185			X	R	280X240	X		
RX	259X259R6	X			RZ	270X185R8	X			R	280X280	X		X
R	260X120	X			R	270X190			X	RX	280X280R6	X		
RA	260X130	X			RR	270X190	X			RZR	281X157	X		
R	260X140	X			RS	270X190	X			RZ	285X155R8		X	
RR	260X140		X		RZ	270X190R8	X			RS	285X170	X		
RZ	260X145R7		X		R	270X195	X			RZ	285X175R8	X		
R	260X160		X		RZS	270X195R10		X		RZ	285X185R8		X	X
R	260X170	X	X	X	RZ	270X195R5		X		R	285X190	X		X
RX	260X170R5	X			R	270X200		X		RZ	285X190R8			X
RZ	260X170R8		X	X	RZ	270X200R8		X		RZ	285X195R6		X	
R	260X175			X	R	270X205		X		R	285X200	X		
RZ	260X175R10	X			R	270X210	X	X	X	RZR	285X220R9		X	
RZ	260X175R9		X		RR	270X210		X		RR	285X285.1	X		
R	260X180	X	X		RZ	270X215R6	X			RR	285X285.2	X		
RZ	260X180R10		X		R	270X225	X			RS	286X248	X		
RX	260X180R6	X	X	X	R	270X230EXTR.FL.	X			RR	287X137	X		
R	260X185			X	RZ	270X230R6	X			RR	287X287	X		
RZ	260X185R8	X	X		R	270X240EXTR.FL.	X			RR	290X160	X		
R	260X190	X		X	R	270X250	X			RR	290X180	X		
RZ	260X190R8	X		X	RXR	270X250R5	X			RR	290X190	X		
R	260X195	X			RX	270X260R5	X			RZ	290X195R6		X	
R	260X200	X	X		R	270X270	X	X		R	290X205	X	X	
RX	260X200R3,5	X	X		RR	270X270	X			R	290X210	X	X	



## Rechteckform · Rectangular shape



Bestellzeichen Marks of order			Konkav	Standard	Optik	Bestellzeichen Marks of order			Konkav	Standard	Optik	Bestellzeichen Marks of order			Konkav	Standard	Optik
RZ	290X230R6		X	X	X	RZ	310X190R9			X		RZ	345X205R7				X
RZ	290X290R5,5			X		R	310X210			X		R	350X200		X		
RR	292X192 Platine		X			RZ	315X200R8			X		RR	350X240		X		
RS	292X282 Talon		X			RZ	315X220R9			X		R	350X310			X	
R	295X160		X			RR	320X155		X			RZR	360X160		X		
R	295X235			X		R	320X190			X		RZ	360X230R8			X	
RZ	299X151		X			RX	320X280			X		RZR	365X130R5		X		
R	300X170			X		RX	320X320-6			X		R	367X132 Platine		X		
RZS	300X205R8			X		RR	324X205		X			RZ	370X160.1			X	
RS	300X215			X		R	327X100 Platine		X			R	370X215			X	
RZR	300X215R9			X		RZR	330X225R9			X		RZR	370X215R8			X	
R	300X230		X			R	330X270			X		R	390X130		X		
RR	300X270 Talon		X			RX	335X145		X			RR	400X140		X		
RZ	302X152		X			RZR	335X200R7			X		R	440X270			X	
R	305X135		X			RZ	335X205R9			X		RZ	440X270R7			X	
RZ	305X180R8			X		R	335X240			X		RZR	464X360.1		X		
R	305X205		X			R	340X150		X			RZ	473X160		X		
RZS	305X220R9			X		RZ	340X150		X			RZR	520X200.1		X		
R	305X305			X		RZR	340X200R8			X							
R	310X190			X		R	340X220			X							



## Tonnenform · Barrel shape

Bestellzeichen Marks of order			Konkav	Standard	Optik	Bestellzeichen Marks of order			Konkav	Standard	Optik	Bestellzeichen Marks of order			Konkav	Standard	Optik
TR	080X165X130				X	T	117X396X290 Platine		X			T	135X130X120		X		
T	085X110X105				X	T	120X100X075				X	TX	135X135X105		X		
T	100X120X095		X			TX	120X100X080			X		TR	139X165X130 Platine		X		
T	100X120X105		X			T	120X120X065		X			T	140X100X085			X	
TX	100X120X105		X			T	120X120X070		X			TX	140X115X100				X
T	100X145X110		X			T	120X120X090		X			T	140X120X100		X		
TR	100X160X130		X			TX	120X160X135		X			T	140X130X055		X		
T	100X200X135 Platine		X			TE	120X165X100		X			TX	140X130X080		X		
TR	100X205X190		X			T	120X165X150		X			T	140X130X105				X
TR	100X340X255		X			TR	120X190X115		X			TE	140X135X060		X		
T	101X146X095		X			TR	120X200X150		X			TXR	140X170X150		X		
T	104X392X300 Platine		X			TR	120X210X175		X			TR	140X180X145		X		
T	105X105X075		X			T	120X329X210 Platine		X			TR	140X196X115		X		
T	105X105X080				X	T	122X329X240		X			T	140X209X160 Platine		X		
TX	105X105X090				X	TZ	124X245X177		X			T	140X245X210		X		
TX	105X105X095				X	TX	125X115X090				X	TR	141X241X170		X		
TR	105X125X110		X			T	125X120X095		X		X	T	145X100X085		X		
T	105X130X105		X			TE	125X120X095		X			T	145X115X080			X	
TR	105X130X115		X			TX	125X120X095				X	T	145X115X095		X		
T	105X165X140			X		T	125X125X090		X			TG	145X120X040		X		
TR	105X270X225		X			TX	125X130X110		X			T	145X120X055		X		
T	105X355X260 Platine		X			T	125X135X105		X			T	145X125X100		X		
T	109X384X290 Platine		X			TX	125X135X115				X	T	145X125X105			X	
T	110X110X095		X			TX	125X140X105		X			T	145X130X110		X	X	X
T	110X125X095		X			TX	125X155X130		X			TXS	145X135X075		X		
T	110X125X110		X			TX	125X155X135		X			T	145X135X100		X		X
TE	110X126X070		X			TX	125X160X135		X			T	145X140X085		X		
T	110X135X120		X			TZ	125X160X140				X	TR	145X171X150		X		
TXR	110X205X195				X	T	125X200X100		X			TX	145X190X125		X		
TR	110X230X215		X			T	130X120X110				X	T	150X105X085			X	
T	112X219X135		X			T	130X125X075		X			T	150X110X085			X	
T	115X110X075				X	T	130X130X070				X	T	150X115X060		X		
TX	115X115X095				X	T	130X130X090		X			TZ	150X115X060		X		
TX	115X115X100				X	TX	130X130X105				X	T	150X115X090			X	
TX	115X125X105		X			T	130X130X110		X			T	150X120X090			X	
T	115X135X110		X			TXE	130X145X100		X			TXR	150X120X090			X	
T	115X140X115		X			T	130X234X130		X			T	150X120X095			X	
T	115X140X130		X			T	135X115X095			X		TXR	150X120X095		X		X
T	115X145X130		X			TE	135X125X100		X			T	150X125X105			X	
T	115X150X105		X			TG	135X130X075		X			TG	150X130X050		X		
T	115X165X125			X		TE	135X130X100		X			TXE	150X130X060		X		



# Tonnenform · Barrel shape



Bestellzeichen Marks of order		Konkav	Standard	Optik	Bestellzeichen Marks of order		Konkav	Standard	Optik	Bestellzeichen Marks of order		Konkav	Standard	Optik
TX	150X135X115			X	TR	173X150X105	X			TE	210X200X170		X	
TG	150X145X110		X		TR	174X154X120	X			TX	210X205X170		X	X
TR	150X200X170	X			T	175X095X080		X		TX	210X205X175			X
TR	150X230X080	X			TE	175X110X070		X		TXR	210X205X190			X
TZ	150X410X300	X			T	175X110X080		X		TX	210X205X195			X
T	155X080X055		X		T	175X110X090		X		TX	210X210X170			X
TZ	155X115X060	X			TZ	175X115X080		X		TX	210X210X175		X	
TX	155X115X065			X	T	175X115X110	X			TZ	210X210X175	X		
T	155X120X090		X		TG	175X125X075		X		TX	210X210X190			X
T	155X120X095		X		TR	175X145X075	X			T	210X230X160	X		
TX	155X120X095	X	X	X	T	175X175X115		X		TXR	210X230X210	X		
TXR	155X120X095	X			TR	175X205X175	X			T	211X102X070	X		
T	155X125X095		X		T	175X270X255	X			TX	211X161X151	X		
T	155X130X040	X			T	175X375X200	X			TR	212X373X210	X		
TXE	155X130X070	X			T	180X080X060		X		TR	214X087X060	X		
TE	155X130X085		X		T	180X110X090		X		TR	215X140X105	X		
T	155X130X090		X		T	180X115X085		X		T	215X150X125		X	
T	155X130X105		X		TE	180X120X075		X		TZ	215X160X135		X	
TX	155X165X125	X			T	180X120X085		X		TZ	215X180X165			X
TX	155X165X130	X			T	180X130X100		X		TG	215X185X100	X		
T	155X215X155		X		T	180X145X105		X		T	215X185X145	X		
TE	155X220X130	X			TS	180X158X065	X			T	215X190X150		X	
T	155X260X140	X			T	180X180X115	X			T	215X190X170		X	
T	156X096X080	X			TS	180X245X100	X			T	215X195X165		X	
TS	156X133X050 Platine	X			TR	182X180X105 Platine	X			TX	215X200X150			X
TR	157X157X080 Platine	X			T	185X125X090		X		T	215X205X155		X	
T	160X100X075		X		TG	185X135X095		X		TXS	215X205X165			X
T	160X105X090		X		T	185X185X150	X			T	215X210X165		X	
T	160X115X075	X			T	185X195X105	X			TX	215X210X180		X	X
TE	160X115X075		X		T	185X230X150	X			T	220X140X100		X	
T	160X115X080		X		TX	185X230X195	X			T	220X155X135		X	
T	160X115X085		X		TS	187X187X115	X			T	220X160X125		X	
T	160X115X100	X			T	190X115X065		X		T	220X160X130		X	
T	160X120X085		X		T	190X115X075		X		T	220X165X140			X
T	160X120X095		X		TR	190X158X092 Platine	X			T	220X170X140		X	
T	160X125X105			X	T	190X165X135		X		T	220X175X150			X
T	160X140X090		X		T	190X180X120		X		TE	220X180X120		X	
TS	160X160X100	X			T	190X190X165			X	T	220X180X150		X	
TX	160X160X145	X			TX	190X190X165	X			T	220X185X155	X		
TR	160X240X120	X			TR	191X191X145	X			T	220X185X170		X	
TR	160X300X140	X			TE	193X209X110	X			T	220X190X135		X	
TR	162X192X148 Platine	X			TE	195X125X070		X		TX	220X190X160			X
T	165X105X070		X		T	195X125X085		X		T	220X200X155		X	
T	165X110X080		X		TE	195X125X085		X		TE	220X200X165		X	
T	165X115X075		X		T	195X170X140		X		T	220X200X180		X	
T	165X115X085		X		TX	195X205X175			X	TX	220X200X180	X		X
TE	165X120X080		X		TER	195X215X110	X			TX	220X205X170			X
T	165X120X095		X		TX	195X245X190	X			TX	220X215X185		X	
T	165X120X100		X		TZ	195X245X200	X			T	220X220X165		X	
TG	165X125X090		X		T	195X316X160	X			TX	220X220X200			X
T	165X130X090		X		TR	198X208X145 Talon	X			T	225X125X080		X	
T	165X130X110		X		TE	198X273X235	X			T	225X135X100		X	
T	165X135X105			X	T	200X110X080		X		T	225X155X120		X	
TS	169X160X055 Platine	X			T	200X120X090		X		T	225X160X125		X	
T	170X105X075		X		T	200X125X090	X			T	225X160X130		X	
TZ	170X105X085		X		T	200X140X080	X			TG	225X160X140		X	
TG	170X110X065		X		T	200X140X120		X		T	225X165X150			X
T	170X110X075		X		T	200X175X155		X		T	225X175X145		X	
TG	170X110X075		X		T	200X200X180		X		TZ	225X180X140		X	
T	170X110X080		X		TX	200X240X210	X			T	225X180X150	X		
T	170X115X080		X	X	T	203X259X235 Talon	X			TZ	225X190X150		X	
T	170X115X085		X		TZ	205X145X115		X		T	225X195X150		X	
T	170X115X095		X		TE	205X170X110 Platine	X			T	225X195X160		X	
T	170X120X085		X		T	205X190X150		X		T	225X195X170		X	
T	170X120X090	X	X		T	205X195X150		X		TZ	225X200X160	X		
T	170X125X095		X		T	205X205X175		X		T	225X200X170		X	
TZ	170X130X065R7	X			TX	205X205X195			X	T	225X200X175			X
TG	170X160X110		X		T	210X145X125		X		TX	225X205X165			X
TR	170X171X100 Platine	X			T	210X175X155		X		TXE	225X205X170			X
TE	171X186X095	X			T	210X190X160		X		TZ	225X205X175			X
T	171X221X110 Talon	X			TX	210X190X160		X		TX	225X215X165	X		
TS	172X135X095	X			T	210X195X125		X		T	225X215X175		X	



# Tonnenform · Barrel shape



Bestellzeichen Marks of order		Konkav	Standard	Optik	Bestellzeichen Marks of order		Konkav	Standard	Optik	Bestellzeichen Marks of order		Konkav	Standard	Optik
T	225X220X150		X		TZ	240X170X130		X		T	255X195X170		X	
TX	225X220X190		X	X	TE	240X170X150		X		TX	255X195X170		X	X
TXR	225X250X210	X			T	240X175X145			X	TE	255X215X150		X	
T	230X180X145			X	TE	240X175X155		X		T	260X160X125		X	
T	230X185X145		X		T	240X180X145		X		T	260X180X135		X	
T	230X190X165		X		T	240X180X155		X		TE	260X180X140		X	
T	230X200X140		X		TZ	240X180X165			X	TE	260X185X140		X	
T	230X200X150		X		TE	240X185X160		X		T	260X190X160		X	
TZ	230X200X150		X		T	240X190X175		X		TE	260X210X170		X	
T	230X200X170	X	X		TG	240X195X100	X			T	260X220X170	X	X	
TG	230X205X160		X		T	240X200X150		X		TX	260X220X180		X	
TE	230X205X165		X		TG	240X200X150		X		TX	260X230X195	X		
TX	230X205X165			X	T	240X200X165		X		T	260X250X195		X	
T	230X210X175		X	X	T	240X210X170		X		TE	260X290X150	X		
TX	230X210X175	X		X	T	240X230X160	X			TS	265X166X105 Talon	X		
T	230X215X175		X		TX	240X230X160		X		T	265X175X130		X	
TX	230X225X190 DACH	X			TX	240X235X160	X			TZ	265X175X135		X	
TX	230X225X195		X		TE	240X260X130	X			TG	265X180X125		X	
TX	230X230X180	X			TR	240X270 Platine	X			T	265X225X205		X	
TZ	230X230X190			X	TX	240X270X245	X			TZ	270X185X150		X	
TX	230X230X195	X			T	240X275X240	X			T	270X210X170		X	
TXR	230X250X210R5	X			T	245X135X090		X		T	270X215X165		X	
TS	230X270X180	X			T	245X180X150		X		TX	270X275X260	X		
T	235X160X130		X		T	245X185X150		X		TR	270X310X235	X		
TR	235X170X130	X			T	245X195X165		X		TG	270X310X235 Talon	X		
T	235X170X150		X		TZ	245X195X165		X		TZ	275X195X160		X	
T	235X175X155		X		T	245X195X170		X		T	275X220X190		X	
T	235X180X150		X		TZ	245X200X150		X		TX	280X230X150		X	
T	235X185X155			X	TZE	245X210X170		X		T	280X240X160		X	
T	235X190X170		X	X	TE	245X215X175		X		TG	280X275X200	X		
T	235X195X160		X		TX	245X215X175	X			TZE	285X210X175		X	
T	235X195X165			X	T	245X220X170		X		TR	285X272X220	X		
TX	235X200X140		X	X	TX	245X220X205			X	TR	290X160X130	X		
T	235X200X160			X	TX	245X225X195			X	T	290X205X155		X	
TX	235X200X170		X	X	TZ	245X230X180		X		TE	290X210X140	X		
T	235X200X175		X		TE	247X263X130	X			T	290X255X160		X	
TZ	235X200X175		X	X	T	250X155X090	X			TR	292X296X235	X		
T	235X205X150		X		T	250X160X110		X		TR	293X263X200	X		
TE	235X205X170		X		TZ	250X170X135		X		TS	295X235X105	X		
TZ	235X205X170	X	X		T	250X175X135		X		TR	298X302X240	X		
T	235X210X165		X		TZE	250X175X165		X		TR	298X318X230 Talon	X		
T	235X220X150	X		X	T	250X180X150			X	T	300X250X210		X	
T	235X220X170		X		TZ	250X180X160		X		T	300X270X170		X	
T	235X225X150		X		T	250X185X150		X		TR	300X310X180	X		
T	235X230X155		X		T	250X210X140		X		TZR	310X140X100	X		
TX	235X235X170			X	T	250X210X175		X		T	310X210X135		X	
TR	235X235X200			X	TX	250X210X190		X		T	310X210X145		X	
TXR	235X240X210	X			T	250X220X175		X		T	315X215X155		X	
TR	235X245X205	X			TX	250X220X175	X			T	350X230X170		X	
TR	240X130X110	X			T	250X230X215		X						
TR	240X150X110	X			T	251X324X257		X						



# Ballenform · Bale shape



Bestellzeichen Marks of order		Konkav	Standard	Optik	Bestellzeichen Marks of order		Konkav	Standard	Optik	Bestellzeichen Marks of order		Konkav	Standard	Optik
B	105X095X105X095	X			BX	135X125X130X080	X			B	150X135X150X135	X		
B	110X095X110X095	X	X	X	B	135X125X135X105	X			BX	150X135X150X135	X		
B	110X100X110X080	X			BX	135X130X115X105	X			BX	150X138X124X105	X		
BX	110X100X110X100	X			BS	140X090X140X090 Platine	X			BX	150X140X120X105	X		
B	115X100X115X100	X			B	140X110X140X110	X			B	150X140X150X140	X		
BR	115X105X110X100	X			B	140X120X115X095	X			BR	150X145X125X115	X		
B	115X105X115X105	X			BR	140X120X120X100	X			B	150X145X130X105	X		
B	120X100X120X100	X		X	B	140X120X125X100	X			BR	151X125X151X125 Platine	X		
BX	120X100X120X100	X			BX	140X120X130X105	X			BR	152X120X152X120 Platine	X		
B	120X100X120X110	X			B	140X120X140X120	X	X	X	B	154X130X154X130	X		
BR	120X105X115X095	X			BR	140X120X140X120	X			B	154X137X140X127	X		
B	120X105X120X105	X			B	140X125X125X100	X			B	155X130X115X095	X		
B	120X110X115X095	X			BR	140X125X130X110	X			BR	155X130X125X100	X		
B	120X110X120X110	X			B	140X125X135X115	X			BX	155X130X130X115	X		
B	120X115X110X100	X			B	140X125X140X125	X			BXR	155X130X145X120	X		
BR	120X115X120X115	X			B	140X130X120X100	X			BX	155X130X155X130	X		
B	124X114X119X096	X			B	140X130X130X115	X			B	155X135X125X100			X
B	125X095X125X095	X			BR	141X075X137X120	X			BX	155X135X125X100			X
BR	125X105X115X090	X			B	143X118X143X118	X			BXR	155X135X130X090	X		
B	125X105X125X105	X			B	144X120X144X120	X			BXR	155X135X130X110	X		
B	125X110X105X090	X		X	B	144X135X124X095	X			B	155X135X155X135	X		
BR	125X110X110X090	X			BX	145X100X130X115	X			B	155X140X125X090	X		
B	125X110X120X090	X			BR	145X100X140X090	X			B	155X140X135X115	X		
BX	125X110X120X090	X			B	145X115X145X115	X			BR	155X140X150X135	X		
B	125X110X120X105	X			BR	145X115X145X115 Talon	X			BR	155X145X115X105	X		
B	125X110X125X105	X			B	145X120X125X105	X			BR	155X145X150X140	X		
B	125X110X125X110	X			BX	145X120X130X120	X			BR	156X130X156X130	X		
BX	125X110X125X110	X		X	B	145X120X145X120	X		X	BS	158X110X158X110 Platine	X		
B	125X115X110X100	X			BR	145X120X145X120	X			BR	158X125X158X125	X		
BX	125X115X115X105	X			BR	145X125X105X080	X			B	158X153X102X076	X		
BR	125X115X120X100	X			BR	145X125X110X095	X			B	159X125X159X125 Talon	X		
BR	125X115X125X115	X			B	145X125X115X095	X			BR	159X135X141X105 Platine	X		
B	125X120X120X100	X			BR	145X125X140X115	X			BR	160X125X160X125	X		
BS	127X120X146X075 Talon	X			B	145X125X145X125	X			B	160X130X160X130	X		X
B	130X100X130X100	X			BX	145X125X145X125	X			BS	160X130X160X130	X		
BR	130X105X120X090	X			BR	145X130X115X110	X			B	160X130X160X135	X		
BR	130X105X130X110	X			BR	145X130X120X105	X			BR	160X136X142X110 Platine	X		
BR	130X110X115X095	X			BX	145X130X125X105	X			BR	160X140X125X105	X		
BR	130X110X120X100	X			B	145X130X145X130	X			BR	160X140X135X110	X		
B	130X110X125X100	X			BX	145X130X145X130	X			BX	160X140X150X140	X		
B	130X110X130X110	X		X	BX	145X135X125X090R4	X			BX	160X140X160X140	X		
BG	130X110X130X110	X			B	145X135X125X100	X			B	160X145X140X080	X		
BR	130X110X130X110	X			BX	145X135X140X085	X			B	160X145X150X135	X		
BR	130X115X110X090	X			B	145X135X145X135	X			B	160X145X160X145	X		
B	130X115X130X115	X			BR	145X135X145X135	X			BX	160X145X160X145	X		
BX	130X115X130X115	X			BX	145X140X125X090	X			B	160X150X130X110	X		
B	130X120X115X105	X			BS	146X065X146X055 Platine	X			BR	160X150X130X115	X		
B	130X120X120X085	X			BR	146X125X135X095 Talon	X			BX	160X150X160X150	X		
B	130X120X120X105	X			B	146X130X125X105	X			BR	161X090X144X130 Platine	X		
B	130X120X130X120	X		X	B	146X138X128X114	X			BR	161X125X161X125 Platine	X		
B	130X125X100X090	X			B	147X124X137X105 Platine	X			BR	161X140X160X110 Platine	X		
B	131X108X131X108	X			BS	148X080X148X080 Platine	X			BR	161X145X130X105	X		
BX	131X120X126X105	X			BX	148X105X139X124	X			BR	162X125X162X125 Platine	X		
B	135X105X135X105	X			B	148X135X122X089	X			BR	163X140X131X100	X		
BR	135X110X105X085	X			BR	150X115X150X115 Platine	X			BR	163X140X142X110	X		
B	135X110X110X085	X			BX	150X120X130X085	X			BR	163X140X146X110 Platine	X		
B	135X110X130X100	X			BR	150X120X150X120	X			B	163X148X140X113	X		
BR	135X110X130X110	X			BX	150X125X140X105	X			BS	164X105X138X080 Platine	X		
B	135X110X140X120	X		X	B	150X125X150X125	X			B	164X130X163X130	X		
BXR	135X115X110X090	X			BR	150X130X120X085	X			BR	164X140X150X122 Talon	X		
B	135X115X130X105	X			BR	150X130X130X105	X			B	165X132X165X132	X		
B	135X115X135X115	X			BZ	150X130X130X110	X		X	BR	165X135X165X135 Platine	X		
BX	135X115X135X115	X			BR	150X130X135X105	X			BX	165X135X165X135	X		
BR	135X120X105X100	X			B	150X130X140X125	X			BXR	165X140X145X100	X		
BR	135X120X110X090	X			BX	150X130X150X130	X			BX	165X140X165X140	X		
B	135X120X110X100	X			BR	150X135X110X085	X			BX	165X145X165X145	X		
B	135X120X135X120	X			BR	150X135X110X105	X			BX	165X150X140X085	X		
BR	135X120X135X120	X			B	150X135X130X100	X			BX	165X150X145X125	X		
BR	135X125X105X100	X			B	150X135X130X105	X			BR	165X155X140X060	X		
BXR	135X125X110X095	X			B	150X135X130X115	X			BS	166X125X138X080 Platine	X		
B	135X125X120X110	X			BX	150X135X130X120	X			BR	166X135X166X135 Platine	X		
BR	135X125X125X110	X			BR	150X135X145X130	X			B	166X152X126X088	X		



# Ballenform · Bale shape



Bestellzeichen Marks of order		Konkav	Standard	Optik	Bestellzeichen Marks of order		Konkav	Standard	Optik	Bestellzeichen Marks of order		Konkav	Standard	Optik
BS 168X098X148X088 Talon	X				BR 183X160X183X160	X				BR 205X170X177X120	X			
BS 168X100X168X100	X				B 183X175X127X100	X				B 205X185X140X120	X			
B 168X150X140X117	X				BR 184X140X184X140	X				B 205X190X175X150	X			
BR 169X140X131X100	X				BR 184X155X161X120	X				B 205X195X126X115	X			
BR 170X135X130X090	X				BR 184X160X145X120	X				B 205X195X175X160	X			
BR 170X135X170X135	X				BR 184X160X155X135	X				B 205X195X180X165	X			
BR 170X140X152X120 Platine	X				BR 185X160X125X090	X				BR 206X175X175X140	X			
BR 170X140X170X140	X				BR 185X165X130X115	X				BS 206X195X206X195	X			
BR 170X145X170X145	X				B 185X170X170X145	X				BR 207X180X186X145	X			
B 170X150X125X105	X				BX 185X170X185X170	X				BR 207X185X168X135	X			
B 170X150X125X115	X				BR 185X175X125X115	X	X	X		BR 208X190X102X070 Platine	X			
B 170X150X170X150	X	X			B 185X180X115X100	X				BX 210X190X210X190	X			
BX 170X150X170X150	X				BR 185X180X135X120	X				BR 210X195X150X125	X			
BX 170X150X170X160	X				BR 186X160X157X135	X				BZR 210X195X205X190	X			
B 170X155X130X100	X				B 186X178X112X085	X				BR 210X200X152X130	X			
B 170X155X170X155	X				B 187X175X185X110	X				BS 210X201X210X201	X			
BR 170X160X120X090	X				B 188X155X188X155	X				BS 211X140X211X140 Platine	X			
B 170X160X165X150	X				BR 188X175X156X095 Platine	X				BR 212X185X208X160	X			
BX 170X160X165X150	X				BR 189X130X187X130	X				BS 212X200X212X200	X			
BR 171X155X144X125 Platine	X				BS 189X135X179X100 Platine	X				BR 215X180X190X175	X			
BS 172X130X152X105 Platine	X				BR 190X150X155X110	X				BR 215X190X115X090	X			
BR 172X143X172X143 Platine	X				B 190X150X190X150	X				BR 215X190X135X085	X			
B 172X160X148X125	X				BR 190X150X190X150	X				B 215X190X190X165	X			
BR 173X138X173X138 Platine	X				B 190X155X190X155	X				BR 215X195X115X090	X			
BR 173X140X173X140	X				BR 190X160X150X120	X				BR 215X195X135X115	X			
BR 173X150X166X135	X				BR 190X160X160X110	X				B 215X195X180X150	X			
B 173X152X155X132	X				B 190X170X150X110	X				BXR 215X195X215X195	X	X		
BR 173X155X165X140	X				B 190X175X155X120	X				B 215X210X120X060	X			
B 173X168X133X123	X				BR 190X180X131X095	X				BR 216X170X191X130	X			
BR 175X130X175X130 Platine	X				BR 191X160X141X105	X				BR 218X110X197X075 Talon	X			
BR 175X135X175X135	X				BR 191X169X161X120	X				BR 219X160X209X120 Talon	X			
BR 175X140X140X120	X				BCL 191X178X172X148	X				B 220X140X198X165	X			
BR 175X140X175X140	X				BR 192X155X192X155	X				BR 220X180X175X125	X			
BR 175X145X137X100 Platine	X				B 192X165X191X165	X				BR 220X185X165X115	X			
BR 175X155X135X095	X				BR 193X180X143X125	X				B 220X185X215X175	X		X	
B 175X160X155X130	X				BR 194X075X194X075 Platine	X				BX 220X190X220X190	X		X	X
B 175X160X160X140	X				BS 194X150X159X095	X				B 220X195X220X195	X			
BR 175X160X177X120	X				BR 195X150X195X150	X				BX 220X195X220X195	X			
B 175X170X145X135	X				BR 195X160X174X130 Platine	X				BR 220X200X120X090	X			
BR 176X087X166X150 Platine	X				B 195X175X125X090	X				BX 220X200X215X200	X			
BS 176X120X176X120 Talon	X				B 195X180X145X110	X				BX 220X200X220X200	X			
BS 176X125X146X125 Platine	X				BS 196X100X196X100	X				BR 220X205X145X115	X			
BR 176X130X176X130	X				BR 196X150X182X140	X				BR 222X185X207X155	X			
BR 176X145X160X130	X				BR 196X155X196X155	X				BR 223X180X223X180	X			
B 176X165X153X102	X				BR 196X160X196X160	X				BR 223X210X191X076 Talon	X			
BS 177X140X160X115 Platine	X				BR 196X170X156X120 Platine	X				BR 225X169X170X130	X			
BR 177X145X177X145 Platine	X				BR 197X157X197X157	X				BX 225X190X150X140	X			
BS 179X080X179X080	X				BR 197X170X155X110	X				B 225X190X220X190	X		X	
BS 179X085X176X140	X				BS 198X130X154X085	X				BX 225X195X225X195	X			
BR 180X130X146X110 Platine	X				BX 198X181T	X				225X200X225X200	X			
BX 180X150X180X150	X				B 200X155X200X155	X				BXR 225X205X210X190	X		X	
BR 180X153X151X113	X				BR 200X170X160X120	X				B 225X210X210X175	X			
BR 180X160X160X135 Talon	X				BR 200X170X169X115	X				B 225X215X200X185	X			
BX 180X160X175X160	X				B 200X170X200X170	X	X			BZR 225X215X225X200	X		X	
BX 180X160X180X160	X	X			BX 200X170X200X170	X				BZR 225X215X225X220	X		X	X
BR 180X165X140X075	X				BR 200X175X168X115	X				BR 226X175X206X170	X			
B 180X165X145X115	X				BR 200X175X170X145	X				BR 226X210X125X085	X			
B 180X165X145X135	X				B 200X180X200X175	X				BR 228X210X208X180 Talon	X			
BX 180X170X155X130	X				B 200X195X135X110	X				BR 229X195X170X120	X			
B 180X170X180X170	X		X		BR 201X165X180X140	X				BR 230X195X180X125	X			
BR 181X150X148X110	X				BR 201X165X198X165	X				BR 230X205X200X155	X			
BR 181X150X156X120	X				BR 201X175X197X145	X				BX 230X205X200X180	X			
BR 181X150X165X135	X				BR 201X185X204X110 Platine	X				B 230X205X230X205	X			
BR 181X156X176X146 Platine	X				B 201X190X201X120 Talon	X				BX 230X210X225X210	X			
BR 181X160X135X085	X				BR 202X140X202X140	X				BX 230X210X230X210	X			
BR 181X160X153X120	X				BR 202X180X202X180	X				BR 230X215X128X090	X			
BR 182X140X146X110 Platine	X				BR 203X160X203X160	X				B 230X215X145X095	X			
BR 182X150X182X150 Platine	X				BR 204X105X193X180 Platine	X				BZ 230X220X140X110	X			
BR 182X155X153X115	X				BR 204X165X201X165	X				BR 231X150X182X095 Platine	X			
BR 182X165X136X085 Platine	X				BR 204X180X164X140	X				BR 231X160X181X110 Talon	X			
BS 183X120X183X120 Platine	X				BR 205X160X175X125	X				BR 231X185X196X175 Talon	X			
B 183X155X187X110	X				BR 205X165X147X115	X				BR 231X210X204X160	X			



# Ballenform · Bale shape



Bestellzeichen Marks of order		Konkav	Standard	Optik	Bestellzeichen Marks of order		Konkav	Standard	Optik	Bestellzeichen Marks of order		Konkav	Standard	Optik
B	235X205X160X115	X			BR	269X220X269X220	X			BR	290X260X220X180	X		
BX	235X210X205X175	X			BR	270X220X270X220	X			BX	290X260X290X260	X		
BX	235X210X215X180			X	BR	270X223X270X223	X			BZR	290X270X190X140	X		
BX	235X215X230X200	X			BR	270X235X240X200	X			BR	290X275X247X225	X		
B	235X220X195X170	X			B	270X250X135X095	X			BR	291X220X291X220	X		
BX	235X220X210X170	X			B	270X250X240X205	X			BR	291X240X291X240	X		
BR	235X222X157X103	X			BX	270X250X240X205	X			BR	292X225X292X225	X		
BX	235X225X195X180			X	B	270X255X235X215	X			BR	292X245X292X245 Talon	X		
BR	238X210X172X135	X			BR	271X219X260X230	X			BR	292X250X264X210	X		
BR	240X200X185X145	X			BR	272X220X223X170	X			BS	292X277X240X216	X		
BX	240X200X240X200	X			BR	272X220X272X220	X			BR	292X278X250X228	X		
BX	240X205X220X170			X	BR	273X265X214X200	X			BR	295X240X294X240	X		
BZR	240X210X185X170			X	BR	275X210X250X190	X			BR	295X250X295X250	X		
BX	240X215X220X175	X			BR	275X230X275X230	X			BR	295X275X160X130	X		
B	240X215X230X170	X			BR	275X240X265X170	X			BRA	296X228X296X228G	X		
BX	240X215X240X215	X			BZ	275X255X145X105	X			BR	296X270X266X225	X		
BR	240X220X120X080 Platine	X			BR	275X255X245X225	X			BR	297X225X268X185	X		
B	240X220X190X140	X			BX	275X255X260X235	X			BR	300X250X230X145	X		
BX	240X220X210X170	X			BR	275X265X125X095	X			BR	300X255X225X145	X		
BXR	240X225X230X210	X			BR	276X245X276X245	X			BR	300X260X260X220	X		
B	240X230X120X100	X			BS	277X150X277X150	X			BR	300X265X255X195	X		
BR	242X215X212X160	X			B	277X255X262X232	X			BR	301X235X301X235 Talon	X		
BX	245X195X245X195			X	BR	278X220X230X155	X			BR	301X260X271X235 Talon	X		
B	245X205X185X170	X			B	278X223X278X223	X			BR	302X265X281X225	X		
BR	245X205X185X170	X			BR	280X220X280X220	X			BR	302X275X302X275	X		
B	245X207X205X160	X			BR	280X225X290X140	X			B	302X287X218X185	X		
BX	245X215X245X215	X			BR	280X228X280X228 Talon	X			BS	303X200X303X200 Platine	X		
B	245X230X165X140	X			BXR	280X230X248X180	X			BR	303X235X303X235 Talon	X		
BZR	245X230X175X160			X	BR	280X240X200X165	X			BR	304X260X304X260	X		
BX	245X235X180X165		X		BR	280X240X280X240	X			BR	305X240X280X180	X		
BR	246X215X131X100 Platine	X			BX	280X240X280X240	X			BR	305X245X275X210	X		
BR	250X200X220X180	X			BX	280X240X280X240R8	X			BR	305X250X300X245	X		
BR	250X210X145X100	X			BX	280X245X280X245R5	X			BR	305X260X250X180	X		
BZR	250X210X185X170	X	X		B	280X250X262X225	X			BR	306X270X286X230 Talon	X		
B	250X225X250X225	X			B	280X250X280X250	X			BR	307X235X307X235 Talon	X		
BR	250X230X200X175	X			BX	280X250X280X250	X			BR	310X235X310X235	X		
B	250X230X250X230	X			BR	280X252X240X190	X			BR	310X250X268X190	X		
B	250X235X240X210	X			B	280X255X200X165	X			BR	310X260X310X260	X		
BR	252X195X251X195	X			BX	280X260X265X235	X			BR	311X260X291X220 Talon	X		
BR	254X205X223X165	X			BX	280X260X265X240	X			B	312X205X281X245	X		
BR	255X210X205X160	X			BR	281X245X281X245 Talon	X			BR	312X220X253X190	X		
B	255X225X255X225	X			BR	282X215X282X215	X			BR	312X260X312X260	X		
BX	255X225X255X225	X			BR	282X230X282X230 Talon	X			BR	312X270X270X225	X		
BR	255X230X170X140	X			BR	282X235X281X235	X			BR	313X255X268X195	X		
BXR	255X230X235X200	X			BS	283X230X241X195	X			BR	313X275X310X250	X		
B	255X230X255X230	X			BR	283X240X283X240	X			BR	315X245X315X245	X		
BS	260X205X260X205 Talon	X			BR	285X215X285X215	X			BR	315X280X265X195	X		
BR	260X215X260X215	X			BXR	285X235X250X200	X			BR	316X265X263X200	X		
BXR	260X230X260X230	X	X		B	285X240X265X210	X			BR	318X260X298X240 Talon	X		
BX	260X230X260X230R5	X			BR	285X245X245X195	X			BR	325X270X325X270	X		
BZR	260X235X200X175	X	X		BR	285X250X205X175	X			BZR	325X315X265X255	X		
B	260X235X220X180		X		BX	285X255X285X255	X			B	330X305X240X205	X		
BR	262X225X262X225	X			BZ	285X260X215X160	X	X		BR	335X295X205X135	X		
BR	263X205X263X205	X			BR	285X260X220X135 Platine	X			BR	338X230X143X100	X		
BS	265X160X255X170 Talon	X			BR	285X265X150X110	X			BR	340X280X275X200	X		
B	265X240X230X160	X			B	285X275X195X175	X			BR	340X310X223X180	X		
B	265X240X255X225	X			BR	286X230X261X210 Talon	X			BR	344X277X277X230	X		
BX	265X240X255X225	X			BR	287X250X262X217	X			BR	355X322X255X202	X		
BX	265X240X265X240	X			BR	288X245X276X230 Talon	X			BR	368X330X298X225 Talon	X		
B	265X250X240X220	X			BR	290X230X260X190	X			BR	395X375X150X085	X		
BS	267X200X267X200 Platine	X			BR	290X230X290X230	X							
BR	267X228X261X204	X			BS	290X245X200X175	X							





## Laternenform · Lantern Shape



Bestellzeichen Marks of order		Konkav	Standard	Optik	Bestellzeichen Marks of order		Konkav	Standard	Optik	Bestellzeichen Marks of order		Konkav	Standard	Optik
L	122X135.1	X			L	144X143.1	X			L	160X145.1	X		
L	122X137.1	X			L	144X156.1	X			L	160X146.1	X		
L	123X123.1	X			L	145X143.1	X			L	160X160.1	X		
LY	125X104.1	X			LX	145X181.1	X			LX	161X155.1	X		
L	125X122.1	X			L	146X141.1	X			L	161X160.1	X		
L	127X118.1	X			LX	146X142.1	X			L	161X202.1	X		
L	130X122.1	X			L	147X125.1	X			L	162X142.1	X		
L	130X125.1	X			L	147X139.1	X			L	162X152.1	X		
L	130X130.1	X			L	148X116.1	X			L	162X152.2	X		
L	130X133.1	X			L	148X131.1	X			L	163X115.1	X		
LY	132X104.1	X			LX	149X137.1	X			L	163X155.1	X		
LY	132x104.2	X			L	149X146.1	X			L	164X140.1	X		
L	132X124.1	X			L	150X120.1	X			L	165X154.1	X		
L	133X140.1	X			L	150X135.1	X			LX	166X144.1	X		
L	134X142.9	X			L	150X135.2	X			L	167X150.1	X		
L	135X112.1	X			L	150X138.1	X			L	168X139.1	X		
L	136X119.1	X			L	150X138.2	X			L	169X158.1	X		
L	136X124.1	X			LX	150X140.1	X			L	170X138.1	X		
L	136X136.1	X			L	150X144.1	X			LX	170X140.1	X		
L	137X134.1	X			L	150X144.2	X			L	171X150.1	X		
L	137X151.1	X			LY	150X146.1	X			L	171X171.1	X		
L	138X113.1	X			L	150X150.1	X			LX	176X160.1	X		
L	138X128.1	X			L	151X127.1	X			LY	177X141.1	X		
L	138X137.1	X			L	151X136.1	X			L	178X160.1	X		
L	138X140.1	X			L	151X171.1	X			LY	178X176.1	X		
L	138X141.1	X			L	152X118.1	X			L	178X182.9	X		
L	138X144.9	X			LX	152X132.1	X			LX	180X170.1	X		
L	139X113.1	X			LX	152X134.1	X			L	185X170.1	X		
L	139X132.1	X			L	152X136.1	X			LX	244X262.1	X		
L	140X122.1	X			L	152X149.1	X			LX	252X251.1	X		
L	140X145.1	X			LX	152X152.1	X			LX	256X252.1	X		
L	141X131.1	X			LX	154X139.1	X			LX	266X264.1	X		
L	142X122.1	X			L	155X135.1	X			LX	270X275.1	X		
L	142X125.1	X			LY	155X149.1	X			LX	272X290.1	X		
L	144X130.1	X			LX	156X149.1	X			L	277X341.1	X		
L	144X138.2	X			L	156X150.1	X							



## Geigenform · Violin shape

Bestellzeichen Marks of order		Konkav	Standard	Optik	Bestellzeichen Marks of order		Konkav	Standard	Optik	Bestellzeichen Marks of order		Konkav	Standard	Optik
G	115X115.1	X			GZ	142X128.1	X			G	160X125.1	X		
GX	120X115.1	X			G	145X120.1	X			GZ	160X130.1	X	X	
G	120X130.1	X			G	145X125.1	X			GX	170X125.1	X	X	
GX	130X120.1	X			G	145X125.2	X			G	174X114.1	X		
G	135X105.1	X			G	145X145.1	X			G	175X145.1	X	X	
G	135X135.1	X			GX	145X145.1	X			G	175X145.2	X		
G	135X135.2	X			G	150X135.1	X	X		G	180X135.1	X		
G	138X128.1	X			G	150X160.1	X			G	220X220.1	X		
G	140X125.1	X			G	155X125.1	X			G	235X205.1	X		
G	140X125.2	X			GX	155X155.1	X							



# Ellipsenform · Elliptical shape



Bestellzeichen Marks of order	Konkav	Standard	Optik	Bestellzeichen Marks of order	Konkav	Standard	Optik	Bestellzeichen Marks of order	Konkav	Standard	Optik
E 112X080.1	X			EY 161X136.1	X			E 188X156	X		
E 122X105.1	X			E 162X132.1	X			E 190X113.1	X		
E 123X110.1	X			E 163X125.1	X			E 190X120.1		X	
E 128X113.1	X			E 163X129.1	X			E 190X120.2	X		
E 130X085.1	X			E 163X133.1	X			E 190X142.1	X		
E 130X116.1	X			EZ 163X138.1	X			E 190X150.1	X		
E 133X110.1	X			E 164X134.1	X			E 190X157.1	X		
E 137X106.1	X			E 164X135.1	X			E 190X161.1	X		
E 138X116.1	X			E 164X139.1	X			E 190X163.1	X		
E 140X105.1	X			E 165X110.1		X		E 191X148.1	X		
E 140X110.1	X			EZ 165X110.1	X			E 191X157.1	X		
EZ 140X115.1	X			EZ 165X133.1	X			E 191X163.1	X		
E 142X112.1	X			EZ 165X144.1	X			E 191X169.1	X		
E 142X116.1	X			E 166X096.1	X			E 192X095.1	X		
EZ 143X112.1	X			EZ 166X136.1	X			E 192X144.1	X		
E 143X116.1	X			E 167X150	X			E 193X156.1	X		
E 143X122.1	X			E 169X132.1	X			E 194X158.1	X		
EY 143X125.1	X			EZ 169X135.1	X			E 194X176.1	X		
E 144X119.1	X			E 169X149.1	X			E 195X095.1	X		
E 144X125.1	X			EX 170X111.1	X			E 195X118.1	X		
E 145X110.1	X			E 170X120.1	X	X		E 195X120.1		X	
E 145X115.1	X			EZ 170X122.1	X			E 195X141.1	X		
E 145X133.1	X			E 170X125.1	X			EZ 195X145.1	X		
E 146X120.1	X			E 170X130.1	X			E 195X172.1	X		
E 146X128.1	X			E 170X133.1	X			E 196X134.1	X		
E 146X132.1	X			E 170X140.1	X			E 196X147.1	X		
EZ 147X104.1	X			E 170X150.1		X		E 196X152.1	X		
E 147X127.1	X			E 171X121.1	X			E 196X163.1	X		
E 147X127.2	X			E 171X142	X			E 196X172	X		
E 148X116.1	X			E 172X132.1	X			E 197X153.1	X		
EZ 148X118.1	X			E 172X138.1	X			E 198X126.1	X		
E 149X117.1	X			E 174X131.1	X			E 198X129.1	X		
E 149X124	X			E 174X144.1	X			E 198X134.1	X		
E 149X124.1	X			E 174X146.1	X			EZ 198X148.1	X		
E 150X109.1	X			E 175X115.1		X		E 198X150.1	X		
E 150X120.1	X			E 175X136.1	X			EZ 199X138-120	X		
E 150X130.1	X			E 175X140.1	X			E 199X144.1	X		
E 151X118.1	X			E 176X131.1	X			E 199X158.2	X		
E 151X121.1	X			EZ 176X133.1	X			E 200X088.1	X		
EZ 152X100.1	X			E 176X143	X			E 200X135.1	X		
EZ 152X108.1	X			E 177X147.1	X			E 200X145.1	X		
E 152X117.1	X			E 178X134.1	X			E 200X146.1	X		
E 152X120.1	X			E 179X134.1	X			E 200X150.1	X	X	
E 152X130.1	X			E 180X072.1	X			E 200X150.2	X		
E 152X132.1	X			E 180X131.1	X			E 200X160.1	X		
E 152X139	X			E 180X136.1	X			E 200X162.1	X		
EZ 153X111.1	X			E 180X140.1	X	X		E 200X180.1	X		
E 153X126.1	X			E 180X149.1	X			E 202X125.1	X		
E 153X135.1	X			E 180X150.1	X			E 202X130.1	X		
E 154X124.1	X			E 180X155.1	X			E 202X183.1	X		
E 154X142.1	X			E 180X160.1		X		E 203X155.1	X		
E 154X144	X			E 181X132.1	X			E 208X143.1	X		
E 155X105.1	X			E 181X162	X			E 208X150.1	X		
E 155X111.1	X			E 182X130.1	X			E 208X180.1	X		
EZ 155X111.2	X			E 182X141.1	X			E 209X136.1	X		
E 155X117.1	X			E 182X149	X			E 209X161.1	X		
E 155X120.1		X		E 182X150.1	X			E 210X154.1	X		
E 155X125.1	X			E 183X142.1	X			E 210X160.1	X		
ECP 155X135.1	X			E 183X169	X			E 210X166.1	X		
E 155X142	X			E 184X113.1	X			E 210X173.1	X		
E 156X129.1	X			E 184X144.1	X			E 210X190.1		X	
E 156X130.1	X			E 184X144.2	X			E 211X135.1	X		
E 156X138.1	X			EZ 185X128.1	X			E 211X185.1	X		
E 158X122.1	X			E 185X131.1	X			E 212X100	X		
E 158X134.1	X			E 185X140.1	X			E 212X163.1	X		
ECP 158X138.1	X			E 186X137.1	X			E 214X170.1	X		
E 159X135	X			E 186X144.1	X			E 214X174.1	X		
E 159X140.1	X			E 186X147.1	X			E 215X175.1	X		
EZ 160X118.1	X			E 186X156.1	X			E 218X160	X		
E 160X125.1	X			E 186X167	X			E 218X162.1	X		
E 160X140.1	X			E 188X142.1	X			E 220X110.1		X	
E 161X092.1	X			E 188X148.1	X			E 220X120.1		X	



## Ellipsenform · Elliptical shape



Bestellzeichen Marks of order		Konkav	Standard	Optik	Bestellzeichen Marks of order		Konkav	Standard	Optik	Bestellzeichen Marks of order		Konkav	Standard	Optik
E	220X140.1		X		EZ	241X190.1	X			E	290X234.1	X		
E	220X175.1	X			E	242X157.1	X			E	293X248.1	X		
E	223X167.1	X			E	244X186.1	X			E	298X247.1	X		
E	223X180.1	X			E	245X195.1		X		EZ	300X150.1	X		
E	224X164.1	X			E	248X198.1	X			E	300X245.1	X		
E	224X169.1	X			E	249X156.1	X			E	300X260.1		X	
E	225X130.1		X		E	250X165.1	X			E	303X250.1	X		
E	225X155.1	X			E	250X180.1	X			E	304X132.1	X		
E	225X162.1	X			E	255X140.1		X		E	305X166.1	X		
E	225X175.1	X			E	255X160.1	X			E	305X171.1	X		
E	226X171.1	X			E	258X162.1	X			E	310X260.1	X		
E	226X177.1	X			E	258X206.1	X			E	311X280.1	X		
E	226X186.1	X			E	260X160.1	X	X		E	315X255.1	X		
E	227X161.1	X			E	260X200.1		X		E	318X266.1	X		
E	228X148.1	X			E	260X204.1	X			E	322X290.1	X		
E	229X179.1	X			E	260X220.1	X			EZ	325X140.1	X		
E	230X125.1		X		E	260X225.1		X		E	328X258.1	X		
E	230X130.1		X		E	264X152.1	X			E	330X142.1	X		
E	230X141.1	X			E	268X205.1	X			E	330X240.1	X		
E	230X150.1	X			E	269X104.1	X			E	335X170.1		X	
E	230X170.1	X			E	270X170.1	X			EZ	335X200R5	X		
E	230X175.1	X			E	270X180.1	X			E	336X203.1	X		
E	231X186.1	X			E	270X210.1	X			E	342X195.1	X		
E	232X177.1	X			E	271X106.1	X			EZ	344X187.1	X		
E	233X153.1	X			E	272X201.1	X			E	356X198.1	X		
E	233X173.1	X			E	274X174.1	X			E	365X145 Platine	X		
E	233X192.1	X			E	275X180.1	X			E	367X207.1	X		
E	234X152.1	X			E	275X215.1	X			EZ	372X225.1	X		
E	234X173.1	X			EZ	279X179R8	X			E	379X180.1	X		
E	235X120.1		X		E	280X235.1	X			E	385X315.1		X	
E	235X135.1		X		E	281X181.1	X			EZ	395X275R6	X		
E	235X185.1	X			E	281X221.1	X			E	400X300.1		X	
E	235X205.1	X			E	282X145.1	X			E	420X250.1		X	
E	237X175.1	X			E	282X185.1	X			EZ	512X340.1	X		
E	238X197.1	X			E	284X181.1	X							
E	238X208.1	X			E	285X173 Platine	X							
E	240X140.1		X		E	286X102.1	X							
E	240X145.1	X			E	288X171.1	X							
E	240X150.1	X			E	288X186.1	X							
EZ	240X175.5	X			E	289X257.1	X							
E	240X197.1	X			E	290X170.1		X						
E	240X215.1	X			E	290X197.1	X							

# Form Kunststoff Unterleg – Fancy Plastic Underlayed



UTZ	151X346X163X358
UTZ	155X330X165X340
URZ	180X122X220X155
NBR	182X152
URB	192X147X225X209
NE	192X152
UB	192X192X216X216
URZ	193X126X218X148
UTZ	194X130X218X156
NE	196X169
URZ	197X127X214X147
URR	199X199X219X219
UB	204X194X230X220
NBR	212X172
URR	214X189X231X206
UT	215X303X278X323
UB	217X192X242X217
URX	220X190X244X214
NR	220X220
URX	220X220X238X238
UR	225X205X235X215
URX	226X196X243X214
UBT	230X295X310X328
UG	235X175X243X183
UB	235X185X250X200
URT	236X213X258X253
UB	236X228X275X256
URX	239X239X263X263
UT	239X294X309X329
URX	240X220X260X240
URX	240X230X260X250
NR	245X190
URZ	248X173X270X190
URZ	248X180X290X210
URX	248X268X278X284
URZ	249X169X285X206
URZ	250X161X285X195
UR	250X170X285X205
URX	250X250X260X260
URR	252X252X280X280
UT	253X293X309X319
URX	255X255X289X289
URZ	256X172X285X198
URX	256X256X285X285
URX	257X237X277X277
URZ	258X189X286X210
UE	258X190X264X195
UR	258X258X275X275
UR	260X196X280X215
UTZ	261X181X289X206
NR	263X245
UTR	263X263X276X276
URX	263X263X280X280
UBX	264X219X272X228
URG	264X264X277X277.1
UR	264X264X277X277.2
UB	264X264X278X278
UR	265X204X278X278

NR	265X205
UR	265X265X278X278
URX	268X248X284X278
URX	268X248X284X278
UT	268X263X300X297
UBX	268X268X283X283
UBZ	269X140X284X155
URX	269X259X292X277
URX	269X259X292X277
URZ	270X185X293X210
UTR	270X223X298X296
UBX	273X233X280X237
UB	274X274X304X304
UB	274X274X305X305
UB	275X255X300X300
UR	275X275X300X300
URT	278X218X308X328
UBT	278X243X271X329
UT	278X278X312X312
UB	279X279X296X296
UR	280X200X302X222
UE	282X170X293X180
UB	283X248X307X295
K	285X220X295X233
NR	287X287
UB	288X202X302X212
UB	288X279X313X310
UB	289X269X332X312
UR	290X270X331X311
URT	295X204X323X277
UR	297X231X308X299
UB	300X276X329X304
UB	302X278X350X302
NBR	303X250
URT	305X173X358X284
UEB	308X259X348X307
UR	319X319X339X339
URZ	320X223X330X240
NRZ	321X219
URR	337X203X350X215
UR	338X232X358X270
URT	348X148X382X180
URZ	362X129X372X139
URZ	375X142X384X151

# Dichtungen – Gaskets



## STERNKREUZ- Dichtungsringe, rund

Viele Uhren enthalten Dichtungen am Gehäuseboden, bisweilen auch am Glassitz (Unterleggläser). Hierfür hält STERNKREUZ ein umfangreiches Sortiment an Dichtungsringen bereit, einzeln verpackt oder auch in Sortierungen. Folgende Dichtungsringe sind lieferbar:

### STERNKREUZ-Gaskets round

Many watches have gaskets at the bottom of the case, sometimes also at the rim of the glass (underlayered glasses). STERNKREUZ keep a comprehensive range of the gaskets, either packed individually or in assorted sizes. The following gaskets are available:

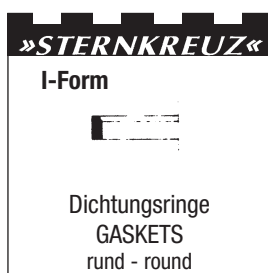

I-Dichtungen für Mineralgläser - hochwertige, schrumpffreie weiße elastische Dichtungen.

Bestellmaß ist der Außendurchmesser des Ringes, in 10tel Millimeter.

I-gaskets for mineral glasses - height-class, shrinkless white elastic gaskets.

The order size is the external diameter of the ring, in tenth millimetres.

I-Dichtungen /Gaskets 140-340 - Höhe / height 0,8, Stärke / thickness 0,35 mm  
alle Nummern lieferbar/all numbers available.

I-Dichtungen / Gaskets 250-327 - Höhe / height 1,2 mm Stärke / thickness 0,4 mm  
alle Nummern lieferbar/all numbers available.



L-Dichtungen für Mineralgläser - hochwertige, schrumpffreie weiße elastische Dichtungen.

Bestellmaß ist der Außendurchmesser des Ringes.

L-gaskets for mineral glasses - high-class, shrinkless white elastic gaskets.

The order size is the external diameter of the ring.

L-Dichtungen/Gaskets 175, 180, 185...-365  
alle 0,5 mm lieferbar/all 0,5 mm available

**O-Dichtungen** = Rundschnurringe aus dauerelastischem Kunststoff, schwarz, für Gehäuseabdichtungen. Das erste angegebene Maß ist der Innendurchmesser, das zweite die Schnurstärke.

**O-gaskets** = extruded string rings made of permanent elastic plastics, black, for case seals. The first size is the inner diameter, the second is the thickness of the strings.

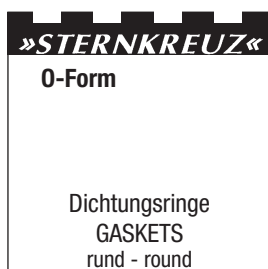

bx	bx	bx	bx	bx	bx
139x5	242x9	275x10	288x8	307x19	330x8
170x8	250x8	277x6	293x10	310x8	335x8
174x6	260x8	280x8	294x8	310x10	336x10
186x7	260x10	280x10	297x10	315x8	345x8
205x8	268x9	282x9	300x6	315x10	
210x6	270x10	288x6	303x7	320x9	

# Dichtungen – Gaskets



**Flachdichtungen** rund aus Kunststoff-Folie, rot, für Unterleggläser und Bodenabdichtungen. Die beiden in der Tabelle aufgeführten Durchmesser sind die Bestell-Durchmesser; u. zwar Innendurchmesser/Außendurchmesser.

**Round flat gaskets** of plastic sheets, red, for underlaid glasses and bottom seals. The two diameters mentioned in the table are the order diameters, i. e. inner/outer diameter.



## Flache Ringe 0,4 mm stark

bx	ax	bx
110x130	195x220	241x255
130x150	196x205	242x252
140x160	197x207	245x260
150x163	199x211	245x264
150x168	200x210	245x270
158x170	200x216	246x256
160x170	200x220	246x270
160x172	200x223	250x263
160x180	201x209	250x265
162x170	202x212	250x266
162x175	205x216	250x280
163x171	205x220	252x268
163x183	205x227	253x272
164x172	208x222	254x269
166x180	208x224	254x274
167x178	210x226	255x270
170x179	212x223	255x275
170x185	212x224	256x280
172x186	213x223	260x268
173x183	213x230	260x270
175x188	214x225	260x290
178x187	216x238	261x274
178x190	217x230	261x277
178x192	220x234	262x272
179x192	220x235	262x275
180x191	223x240	262x278
180x195	223x250	262x282
182x190	224x234	262x283
182x192	230x260	263x284
183x196	233x250	264x280
183x204	234x260	264x290
183x206	235x250	265x277
188x200	237x260	265x284
188x203	233x245	265x293
192x200	240x250	265x295
194x205	240x253	266x279
195x213	240x255	266x280
195x216	240x280	

## Flat gaskets, 0,4 mm thick

bx	ax	bx
267x287	282x295	305x315
268x284	282x314	305x321
268x288	283x297	307x320
270x280	283x304	308x328
270x285	285x295	309x316
270x287	285x300	310x320
270x290	285x305	310x324
270x295	285x315	311x324
270x296	285x320	315x331
270x298	290x298	315x333
270x300	290x300	315x338
270x303	290x305	315x340
270x306	290x308	315x343
272x290	290x310	318x330
272x300	290x320	320x335
272x304	290x329	320x340
272x306	290x333	325x335
272x308	291x306	325x340
272x310	292x306	325x345
274x283	292x308	340x355
275x285	292x312	358x370
275x290	292x316	360x386
275x295	294x308	365x385
275x300	294x314	378x390
275x303	295x305	
276x282	296x308	
276x284	296x309	
276x294	296x328	
277x290	298x316	
278x286	299x310	
278x288	300x316	
278x298	300x331	
280x295	301x317	
280x300	301x319	
280x306	302x325	
280x309	303x310	
280x310	303x328	

Flachdichtungen liefern wir außerdem in Sonderabmessungen. Bei Bedarf geben Sie uns bitte das gewünschte Maß bekannt, damit wir prüfen können, ob diese Größe vorhanden ist.

Furthermore, flat gaskets are also available in special dimensions. In case of demand please inform us of the required measurement, so that we can check whether it is available.

# Weckergläser rund und Großuhrengläser

## Glasses for alarm clocks round



STERNKREUZ liefert runde Weckergläser, sowohl aus Mineralglas unter der Kurzbezeichnung „**MMG**“, als auch in lichtechem und formbeständigen Kunststoff (zum halben Gewicht) unter der Kurzbezeichnung „**MP**“.

Die lieferbaren Querschnitte können Sie aus den nachfolgenden Zeichnungen ersehen, ebenso die lieferbaren Größen und die ungefähren Innenhöhen dieser Gläser.

**Achtung:** Während Armbanduhrgläser in der Nummerierung grundsätzlich 10tel Millimeter verwenden, werden Weckergläser in vollen Millimetern klassifiziert, bestellt und geliefert.

STERNKREUZ supplies round glasses for alarm clocks, not only made of mineral glass under the abbreviation "**MMG**", but also made of plastics (half the weight) which is fast to light and which has a dimensional stability under the abbreviation "**MP**".

The available cross sections as well as the available sizes and the approx, internal heights of these glasses can be seen from the following drawings.

**Attention:** Whereas wrist watch glasses are always numbered in tenth millimetres, the glasses for alarm clocks are classified, ordered and supplied in full millimetres.

### Mineral Miconcave Großuhrgläser / Mineral Miconcave Glasses for Alarm Clocks

**MMG** 50- **MMG** 120 alle Nummern lieferbar / all numbers available

**MMG** 120- **MMG** 200 alle geraden Nr. lieferbar / all even numbers available

**MMG** 200- **MMG** 330 alle 5 Millimeter lieferbar / all 5 mm available



**MMG**



für gewölbte Gläser	60 mm	Wölbungshöhe	5- 6 mm
im Durchmesser bis:	70 mm	innen:	6- 7 mm
	90mm		7- 8 mm
for domed glasses in	100 mm	interior	8 - 9 mm
the diameter up to:	120 mm	doming height:	8,5-10 mm
	140 mm		10-11mm
	160 mm		11-12mm
	170 mm		12-13 mm
	180 mm		13-14mm
	190mm		13-15 mm
	200 mm		15-16 mm
	210 mm		16-17 mm
	220 mm		18-19 mm
	240 mm		19-20 mm
	260 mm		20-21 mm
	300 mm		22-23 mm
	330 mm		24-25 mm

### Miconcave Großuhrgläser aus Kunststoff / Alarm Clocks made of Plastics

**MP** 50,0 - **MP** 80,0 alle 0,5 mm lieferbar / all 0,5 mm available

**MP** 80,0 - **MP** 120,0 alle 1,0 mm lieferbar / all 1,0 mm available

**MP** 127,5 - **MP** 187,5 alle 10 mm lieferbar / all 10 mm available

Diese STERNKREUZ-Miconcave-Gläser sind im Spritzgießverfahren hergestellt und dürfen nur spannungsfrei eingebaut werden. Man darf diese Gläser jederzeit am **Rand einklemmen**, sie dürfen aber in der Oberfläche keine Wölbungsspannung erhalten.

These STERNKREUZ-Miconcave glasses are manufactured by injection moulding and they can only be fitted strainlessly. These glasses can always be **squeezed in at the edges**, but in the surface there should not be a doming tension.



**MP**



Wölbungshöhen / doming heights:			
für gewölbte Gläser	59,5 mm	Wölbungshöhe	4,0- 4,5 mm
im Durchmesser bis:	72,0 mm	innen:	4,5- 5,0 mm
	80,0 mm		5,0- 5,5 mm
for domed glasses in	90,0 mm	interior	7,0 - 8,0 mm
the diameter up to:	100,0 mm	doming height:	7,5- 8,0 mm
	110,0mm		8,5- 9,5 mm
	120,0 mm		9,5-10,5 mm
	127,5 mm		11,0 mm
	137,5 mm		11,0 mm
	147,5 mm		11,5 mm
	157,5 mm		12,0 mm
	167,5 mm		12,5 mm
	177,5 mm		13,0 mm
	187,5 mm		14,0 mm

# Marken- und Kaliberschlüssel

## Key to brands and calibres



Soweit uns die Uhrenmarken und Kaliber, für welche die Rundglas-Sonderformen passen, bekannt sind, haben wir diese bei den Gläserzeichnungen angegeben. Leider ist in vielen Fällen nur der Gehäusehersteller und nicht die Uhrenmarke bekannt. In dieser Liste finden Sie nach Marken zusammengefaßt die für diese Marken im Katalog enthaltenen Uhrgläser. Für Hinweise und Ergänzungen sind Großhandel und Hersteller jederzeit dankbar.

As far as we know the watches and calibres, to which our special forms round correspond, we indicated these next to the drawings of the glasses. Unfortunately in many cases only the case manufacturer and not the watch brand is known. In this list you will find the watch glasses for these brands as they are contained in the catalogue. Further references and supplements will always be appreciated by the wholesale trade and the manufacturer.

### ARISTO

REFERENZ-NR.	ORDER-NR.	
02150	BS	265x160x255x170T
0540	BR	281x245x281x245T
056	BR	306x270x286x230T
058	RR	300x270 TALON
05990	TR	285x272x220 TALON
1101	MRS	166x156.1
1121	XMF	160.866
1140	MTS	153x136.1
1205	X	162.067
1207	X	157.066
1209	X	157.066
1219	BS	160x130x160x130
12400	MBS	171x133.1
12880	ME	171x145.1
1300	MBR	192x172.1
1350	MBS	199x188.1
1360	MBS	199x188.1
1390	MBS	212x182.1
3800	ME	153x101.1
7160	MRR	235x215.1
11100	MRR	162x141.1
11370	MTS	151x131.1
11600	MBR	144x125.1
11800	MBR	176x141.1
11900	MBS	154x154.1
16580	BR	273x265x214x200
16670	TS	265x166x105 TALON
16700	XMF	175.867
17 ..	FB	208.958
1704	BR	222x185x207x155
2101	MRR	272x252.1
2190	MBS	287x256.1
28 ..	FT	325.950
32 .. /2	FTA	325.934
33 .. /2	FTA	325.934
34 .. /2	FTA	325.934
35 .. /2	FTA	325.934
5101	MTR	247x288.1
5200	MTR	228x288.1
5604	BR	311x260x291x220
57 ..	FT	325.950
5721	FTA	311.395
58 ..	FT	325.950
T 25. . GLAS O. MIN. RING	XAC	325.517
T 36 .. GLAS O. MIN. RING	XAC	325.517
T 37 .. GLAS O. MIN. RING	XAC	325.517
	X	312.013
	X	318.012
MIT LANGLUPE	XAG	324.546
MIT LANGLUPE	XAC	324.547
RING FÜR XAC 325.517	X	358.520

### BAUME ET MERCIER

REFERENZ-NR.	ORDER-NR.	
1187	XAG	257.674
1188	XAG	266.673
1215	XAG	217.675
1214/16	XAG	225.666
	XAG	206.740
	XAG	256.741
	XAG	215.742
	XAG	220.699
	XAG	260.700

### BREIL

REFERENZ-NR.	ORDER-NR.	
Breil 1900	XMF	264.713
Breil 1901	XMF	256.714

### BWC

REFERENZ-NR.	ORDER-NR.	
435003	HW	188
753082	XMD	307.813
793010	ATC	313
795013	DIA-C	317
813008	ATCB	302
953004	XAO	322.554
953011	XAC	307.561

### CERTINA

REFERENZ-NR.	ORDER-NR.	
68.01.002	FB	301.355
68.01.003	FB	329.356
68.01.004	FBA	312.352
68.04.007	FBA	323.353
7701-001	FTA	312.351
778 0001 41 OD	MBR	330x250.1
982/1 16,0-0	ATC	161
982/1 28,5-6	ATCR	287
982/1 29,5-3/5	XAC	297.518
982/1 29,5-1	XAG	297.519
982/1 30,5-7	XAC	307.516
982/1 31,0-22	XAG	311.676
982/1 31,5-9	XAC	316.515
982/10 31,0-6	XAC	312.680
982/10 31,0-15	XAC	312.678



# Marken- und Kaliberschlüssel

## Key to brands and calibres



### CITIZEN

REFERENZ-NR.	ORDER-NR.	
40-4179	MB	274x304.1
54-00200	XS	311.423
54-00200	XS	311.448
54-0046	XS	321.424
54-0054	XS	330.425
54-01260	XS	340.443
54-0153	XS	310.426
54-01530	XS	310.442
54-01800	XS	205.447
54-01870	XS	265.446
54-01980	XS	295.453
54-03421	XAC	311.588
54-0385	XAC	306.605
54-03961	XAG	311.613
54-03961	XAC	311.585
54-0408	XAC	286.586
54-04201	XAC	201.587
54-04202	XAG	201.606
54-04221	XAC	231.658
54-04241	XAC	261.659
54-04281	XAC	281.604
54-04941	XAC	211.657
54-05141	XAC	211.603
54-05142	XAG	211.602
54-05341	XAC	246.687
54-05351	XAC	231.688
54-05361	XAC	296.694
54-05491	XAC-FAC	221.689
54-05701 S	XAC	311.656
54-05721 S	XAC	297.655
54-05731 S	XAC	311.690
54-0578 S	XAC	196.653
54-05781 S	XAC	196.653
54-05851 S	XAC	311.660
54-05911	XAC	217.654
54-05921 S	XAC	296.691
54-06121 S	XAC	291.692
54-06151 S	XAC	211.693
54-07240	FT	302.388
54-7250	FT	303.389
54-07600	UBT	278x243x271x329
54-0776	UT	268x263x300x297
54-07780	FT	302.374
54-12425 F	MTS	265x265.1
54-16015 F	MTR	243x283.1
54-16025 F	MTR	238x268.1
54-17895 F	MBR	235 x280.1
54-19275 F	MBR	274x274.1
54-21117 F	MRS	281x269.1
54-21118 F	MRR	270x255.1
54-31026 E	TE	198x273x235
54-31068	T	203x259x235 TALON
54-31072	R	211x178 TALON
54-31206	MR	221x186.1
54-33880	BR	260x215x260x215
54-33900	BR	271x219x260x230
54-40130	BCL	191x178x172x148
54-48449 S	RR	251x221
54-48480 S	B	144x120x144x120
54-04182	XAG	311.697
54-05701	XAG	311.697
	XAC	206.683

### Fortsetzung / Continuation CITIZEN

REFERENZ-NR.	ORDER-NR.	
	XAG	206.696
54-48482 S	BR	270x223x270x223
54-48449 S	RR	251 x221
54-50440	XMF	307.878
54-50480	XMF	277.830
54-50520	XMF	307.879
54-50940	XMF	204.880
54-51060	XMF	287.829
54-56560	XMF	302.881
54-56730 S	XMF	204.882
54-56770	XMF	307.883
54-6055	MBR	294x276.1
54-70200	XMF	307.884
54-70260	XMF	307.885
54-70460	XMF	299.886
54-71140	XMF	206.887
54-71250	XMF	297.888
54-71260	XMF	306.889
54-71720	XMF	202.890
54-74820	MBR	310x300.1
54-75580	MTR	271x311.1
54-75820	MTR	240x290.1
54-76270	MTR	250x310.1
54-76580	MBR	300x250.2
54-76940	MBR	310x223.1
54-76960	MTR	285x314.1
54-77000	XMF	307.891
54-77030 S	XMF	302.892
54-77430 S	MTS	300x240.1
54-77440 S	MBR	295x235.1
54-77470 S	MBS	190x175.1
54-77530 S	MBR	200x185.1
54-77550	XMF	276.893
54-77650 S	XMF	292.894
54-77740 S	MBR	280 x235.1
54-77750 S	MBR	280x235.1
54-78750	MTR	230x295.2
54-79010	MTR	209x299.1
54-79170	MBR	330x240.1
54-79830	MTR	263x308.1
54-89019	LCD-MT	253x303.1
54-90705 F	XMF	281.895
54-92610	XMF	292.896
54-94200	MBR	304x289.1
54-94230	MBR	230x230.1
54-98420	MTS	289x239.1
54-99405 G	MBR	281 x241.1
54-U 0016	MBS	294x259.1
	MBS	167x158.1
	MBR	180x157.1
	MBR	185x185.2
	ME	188x148.1
	MBS	192x192.1
	MRR	202x102.1
	XAC	310.538
	XAC-FAC	310.539
	XS	311.111
54-04182 S	XAC	311.356
54-31293 E	XMF	193.922
54-31505	MBR	290x248.1
54-31508	MRS	190x170.1
54-51650	XMF	283.923

# Marken- und Kaliberschlüssel

## Key to brands and calibres



Fortsetzung / Continuation **CITIZEN**

REFERENZ-NR.	ORDER-NR.
54-58330	MBR 193x173.1
54-59910	MBR 158x148.1
54-63141	XMF 318.924

### DUGENA

REFERENZ-NR.	ORDER-NR.
1378	UB 300x276x329x304
342 144/296	MBR 334x293.1
3450.618	ME 382x302.2
512.013	XAC 316.560
834 373/296	MB 320x290.1
851.145	XMD 325.805
851.145	XY 325.220
859 239	FBA 310.373
869 174.150	MT 240x298.1
869 364/193	LED-MB 270x217.1
869 384 S/W-AUFD RUCK	LCD-MBR245x199.1
891 133	MBR 270x270.1
899 123 149	MTR 242x270.1
99 1011	MBR 185x185.1
99 1021	ME 194x163.1
99 1031	MBR 184x184.1
99 1041	ME 197x163.1
99 1051	XMF 185.823
99 1061	XMF 185.823
A 1127.414	XMF 304.817
A 1648.0	MTR 271x277.1
A 1648.0 ANDERER DRUCK	MTR 271x277.2
A 3116.422	MBR 289x289.1
A 5115.518	XMD 310.814
A 8602.911	MTS 226x268.1
A 8905.211	LCD-MB 298x298.1
A 8911.111	LCD-MBS 330 x310.1
A 9921.311-149	LCD-MBR 245x199.1
A 9922.321 BRAUN/GOLD	LCD-MBR 245x199.2
E 2201.610	MBR 181x176.1
E 4115.318	XMF 227.816
E 5106.418	XMF 187.815
34.50.618	ME 382x302.2
45.69.718	XMF 298.820
46.40.718	XMF 315.818
J 3747.718	XAC 311.601
J 4180.058	XAC 287.600
MONZA	XAG 288.589
MONZA	XAC 288.590
P 322	MTR 308x240.1
PRÄTINA	FB 312.392
U 022.511 225	MBR 300x250.1
U 3162.618	ME 342x312.1
U 3164.518	MB 317x317.1
V 2200.528	ME 228x207.1
X 2710.211	LDC-MBR 309x248.1

### HANHART

REFERENZ-NR.	ORDER-NR.
KAL. 1012	XS 491.121
KAL. 1021	XS 575.120

Fortsetzung / Continuation **HANHART**

REFERENZ-NR.	ORDER-NR.
KAL. 1022	XS 485.115
	XS 538.122

### IMMERSION

REFERENZ-NR.	ORDER-NR.
Immersion Full	XMH 285.400
Immersion Stream	XMH 325.401
Immersion Stream	XMH 315.402

### JUNGHANS

REFERENZ-NR.	ORDER-NR.
010/1741	MRR 279x279.1
010/1742	MRR 279x279.1
010/1811	RS 292x282TALON
010/1812	RS 292x282 TALON
010/1816	BR 303x235x303x235T
010/1817	BR 303x235x303x235T
010/2611	X 325.051
010/2612	X 325.051
010/3701	MBR 294x292.1
010/3702	MBR 294x292.1
010/4631	TR 298x318x320 TALON
010/4632	TB 298x318x320 TALON
010/4641	BR 318x260x298x240T
010/4642	BR 318x260x298x240T
010/4643	BR 318x260x298x240T
010/4644	BR 318x260x298x240T
010/4645	BR 318x260x298x240T
010/4721	X 325.051
010/4723	X 325.051
010/4724	X 325.051
010/4741	MRR 279x279.1
010/4742	MRR 279x279.1
010/4743	MRR 279x279.1
010/4744	MRR 279x279.1
010/4750	MTR 290x280.1
010/4751	MTR 290x280.1
010/4756	MTR 290x280.1
010/4757	MTR 290x280.1
010/4801	X 325.051
010/4802	X 325.051
010/4803	X 325.051
010/4901	X 325.051
010/4902	X 325.051
010/4903	X 325.051
010/5611	X 325.051
010/5612	X 325.051
010/5703	MBR 294x292.1
010/6711	X 325.050
010/6712	X 325.050
010/6716	X 325.050
010/6717	X 325.050
010/7631	TR 298x318x320 TALON
010/7641	BR 318x260x298x240 T
010/7712	X 325.050
010/7716	X 325.050
010/7741	MRR 279x279.1
010/7750	MTR 290x280.1
010/7811	RS 292x282 TALON

# Marken- und Kaliberschlüssel

## Key to brands and calibres



Fortsetzung / Continuation JUNGHANS

REFERENZ-NR.	ORDER-NR.	
010/7812	RS	292x282 TALON
010/7816	BR	303x235x303x235T
011/1641	E	328x258.1 TALON
011/1642	E	328x258.1 TALON
011/1741	E	328x258.1 TALON
011/1742	E	328x258.1 TALON
011/4731	LCD-RR	149x239
011/4761	PL-RR	292x192
011/4762	PL-RR	292x192
011/7741	E	328x258.1 TALON
015/0011	BR	231x185x196x175 T
015/0012	BR	231x185x196x175 T
015/0024	B	201x190 x201 x120 T
015/0025	B	201x190 x201x120 T
015/0026	BR	218x110x197x075 T
015/0027	BR	218x110x197x075 T
015/0039	RR	213x183 TALON
015/0040	RR	213x183 TALON
015/2075	BR	223x210x191x076 T
015/2080	BR	231x160x181x110 T
015/2104	RR	201x171 TALON
015/2741	MRR	199x189.1
015/2742	MRR	199x189.1
015/2801	BR	219x160x209x120 T
015/2841	MRR	199x189.1
015/2842	MRR	199x189.1
015/2902	T	171x221x110 TALON
015/2904	RR	201x171 TALON
015/5075	BR	223x210x191x076 T
015/5080	BR	231x160x181x110 T
015/5104	RR	201x171 TALON
015/5178.60	BR	223x210x191 x076 T
015/5181.60	BR	231x160x181x110 T
015/5741	MRR	199x189.1
015/5742	MRR	199x189.1
015/5801	BR	219x160x209x120 T
015/5841	MRR	199x189.1
015/5842	MRR	199x189.1
015/5901	BR	219x160x209x120 T
015/5902	T	171x221x110 TALON
015/5904	RR	201x171 TALON
015/5960.44	T	171x221x110 TALON
017/2010	BR	226x175x206x170 T
017/2015	BR	226x175x206x170 T
017/5010	BR	226x175x206x170 T
017/5011	BR	226x175x206x170 T
017/7015	BR	226x175x206x170 T
018/5007	MBR	247x131.1
018/5009	MBR	247x131.1
020/2025	BR	301x235x301x235 T
020/2035	MBR	280x280.1
020/2912	BR	286x230x261x210 T
020/2921	BR	301x260x271x235 T
020/2931	RR	243x243 TALON
020/2961	MRS	289x279.1
020/2971	BR	301x260x271x235 T
020/4095	MBS	279x260.1
020/4096	MBS	279x260.1
020/5062	MBR	279x239.1
020/5912	BR	286x230x261x210 T
020/5921	BR	301x260x271x235 T
020/5931	RR	243x243 TALON

Fortsetzung / Continuation JUNGHANS

REFERENZ-NR.	ORDER-NR.	
020/5961	MRS	289x279.1
020/7025	BR	301x235x301x235 T
020/7035	MBR	280x280.1
020/7971	BR	301x260x271x235 T
022/2135	MTS	279x279.1
022/2136	MTS	279x279.1
022/2137	MTS	279x279.1
022/2278	MTS	279x279.1
022/4145	MBS	289x279.1
022/4146	MBS	289x279.1
022/4147	MBS	289x279.1
022/4148	MBS	289x279.1
022/4149	MBS	289x279.1
022/4150	MBS	289x279.1
022/7145	MBS	289x279.1
022/7146	MBS	289x279.1
022/7278	MBR	289x269.1
022/7279	MBR	289x269.1
031/2262	MBR	169x154.1
031/5262	MBR	169x154.1
031/5263	MBR	169x154.1
031/5264	MBR	169x154.1
040/7262	MRR	265x270.1
062/4505	XAC	322.572
062/4506	XAC	322.572
062/7505	XAG	322.571
93/1954	X	310.028
93/1954	X	312.027
93/1954	X	314.006
93/1954	X	316.007
93/1954	X	318.008
42.197-0234	XAC	316.560
42.197-0563	X	224.049
42.197-0822	TR	298 x 318 x 320 TALON
42.197-0825	BR	318x260x298x240T
42.197-0826	BR	368 x 330 x 298 x 225 T
42.197-0827	TA	198x208x145 TALON
42.197-0829	BR	228x210x208x180T
42.197-0831	E	368 x318.1 TALON
42.197-0832	E	248x198.1 TALON
42.197-0833	X	326.065
42.197-1009	XAC	225.671
42.197-1035	XAG	225.672
42.197-1086	X	305.063
42.197-1097	X	309.060
42.197-1114	X	202.064
42.197-1315	XAG	212.668
42.197-1316	XAC	227.669
42.197-1317	XAG	227.670
42.197-1962	X	313.062
42.080-1395	PL-RR	292x192
42.080-1396	PL-RR	292x192
42.080-1397	PL-RR	292x192
42.080-1398	MTR	290x280.1
42.080-1399	MTR	290x280.1
42.080-1400	MTR	290x280.1
FÜR MINUTENRING	XAO	327.400
	XAC	292x508
	X	318.040
	XMD	337.829

# Marken- und Kaliberschlüssel

## Key to brands and calibres



### MIKADO

REFERENZ-NR.	ORDER-NR.
D 0006	FT 310.399
4 G 3006	XAG-FAC 286.609
4 G 3006	XAC-FAC 286.610
4 G 3008	XAG 296.611
4 G 3008	XAC 296.612
4 G 3009	XAG 300.614
4 G 3009	XAC 300.615
4 G 3010 C	XAG 311.613
4 G 4005	XS 294.431
4 G 4006	FE 295.446
4 G 4007	FB 302.447
4 G 4008	FB 302.443
4 G 4011	XS 316.432
4 G 4014	XS 350.433
4 G 4016	XS 389.434

### OLYMPIC

REFERENZ-NR.	ORDER-NR.
1670 C	XMD 310.826
1899/2789	XMD 308.807

### OMEGA

REFERENZ-NR.	ORDER-NR.
2105	UB 274x274x305x305
5072	XAC 316.597
5072	XAG 316.607
5077 SPEEDMASTER	XAC 342.594
5083	XAG 330.556
5083	XAC 330.552
5116	XAC 225.551
5117	XAG 225.550
5117	XAC 225.555
5123	XAG 330.557
5123	XAC 330.553
5137	XAC 316.595
5142	XAC 316.595
5200	XAC 316.549
5200	XAG 316.548

### ORFINA

REFERENZ-NR.	ORDER-NR.
PORSCHE DESIGN	XMF 370.803
PORSCHE DESIGN	XMF 373.804
PORSCHE UNISEX	XMF 255.868

### ORIENT

REFERENZ-NR.	ORDER-NR.
OS 212	XS 310.177
OS 215	XS 308.176
OS 215 M.DRÜCKER	XS 319.183
OS 217	XS 310.178
OS 227	XS 319.184
OS 238	XS 314.181
OS 252	XS 319.183
OS 308	XS 314.417
OS 309	XS 314.417

### Fortsetzung / Continuation ORIENT

REFERENZ-NR.	ORDER-NR.
OS 310 M.DRÜCKER	XS 314.180
OS 318 M.DRÜCKER	XS 319.182
OS 318 M.DRÜCKER	XS 319.416
OS 319 M.DRÜCKER	XS 314.417
OS 322	XS 319.183
OS 326	XS 314.181
OS 326 M.DRÜCKER	XS 314.179
OS 327	XS 319.184
OS 329	XS 319.182
OS 337	XS 319.416
OS 342 M.DRÜCKER	XS 297.175
OS 345	XAC 306.568
OS 346 M.DRÜCKER	XS 297.174
OS 501	XMD 324.801
OS 533	XMD 315.808
OS 541 M.DRÜCKER	XS 319.184
OS 544	XMD 315.809
OS 575	XMD 295.800
OS 578	XMD 295.800
OS 711	XS 204.419
OS 718	XS 204.419
OS 729	XS 210.421
OS 5086	XMD 295.800
OS 5096	XMF 298.802
OS 429-1.6840	UB 302x278x350x302
15-055 S	XAC 321.577
15-057 S	XAC 307.578
15-993 S	XAC 317.579
16-017	XS 390.135
16-105 P	XS 308.194
16-231	FB 318.367
16-231 P	FB 318.367
16-239	XS 311.191
16-239 P	XS 311.191
16-244	XS 375.190
16-265	XS 308.194
16-265 P	XS 308.194
16-306	FE 209.368
16-306 P	FE 209.368
16-418	XS 335.113
16-418 P	XS 335.113
16-419	XS 326.192
16-419 P	XS 326.192
OS 541 M.DRÜCKER	XS 319.184
OS 544	XMD 315.809
OS 575	XMD 295.800
OS 578	XMD 295.800
OS 711	XS 204.419
OS 718	XS 204.419
OS 729	XS 210.421
OS 5086	XMD 295.800
OS 5096	XMF 298.802
OS 429-1.6840	UB 302x278x350x302
15-055 S	XAC 321.577
15-057 S	XAC 307.578
15-993 S	XAC 317.579
16-017	XS 390.135
16-105 P	XS 308.194
16-231	FB 318.367
16-231 P	FB 318.367
16-239	XS 311.191
16-239 P	XS 311.191

# Marken- und Kaliberschlüssel

## Key to brands and calibres



### Fortsetzung / Continuation **ORIENT**

REFERENZ-NR.	ORDER-NR.
16-244	XS 375.190
16-265	XS 308.194.308
16-265 P	XS 308.194
16-306	FE 209.368
16-306 P	FE 209.368
16-418	XS 335.113
16-418 P	XS 335.113
16-419	XS 326.192
16-419 P	XS 326.192
16-420	XS 311.191
16-428	FT 300.369
16-428 P	FT 300.369
16-457	FR 308.390
16-457 P	FR 308.390
16-478	XS 395.193
16-588	XS 385.441
16-588 P	XS 385.441
16-622 C	XMF 360.822
16-870	XS 390.123
16-916	XS 390.119
16-924	XS 340.112
16-959	XS 336.197
16-966	XS 336.195
16-974	XS 390.163
16-974 P	XS 390.163
16-983	XS 302.196
16-985	XS 326.192
16-991	XS 336.418
16-1031	XMF 285.841
16-1031 C	XMF 285.841
16-1038	MBR 295x210.1
16-1052	MTR 200x300.1
16-1059	XS 308.194
16-1059 P	XS 308.194
16-1119 C	MTR 241x301.1
16-1126 C	MBR 321x261.1
16-1260	ME 354x324.1
16-1387	ME 354x304.1
16-1620	XMF 295.839
16-1620 C	XMF 295.839
16-1838 C	XMF 283.838
16-2160	MRR 239x224.1
16-2332 C	XMF 298.842
16-2336	MRS 179x164.1
16-2363	MBS 259x244.1
16-2379	MBR 149x149.1
16-2380	MTR 251 x256.1
16-2391	MTR 154x149.1
16-2410	MBS 249x229.1
16-2451	XMF 275.840
16-2474	MRS 265x235.1

### **OSCO**

REFERENZ-NR.	ORDER-NR.
141/17	FT 310.382
16/7	FB 289.346
16/25	FB 321.385
16/26	FB 321.385
16/29	FE 318.383
233/5	FE 318.383

### Fortsetzung / Continuation **OSCO**

REFERENZ-NR.	ORDER-NR.
233/13	XAC 316.593
25-2	FT 300.345
64/412	FB 298.344
64/487	FT 309.381
64/499	FB 289.346
64/501	FB 299.347
64/505	FBA 327.348
64/513	FB 296.342
64/515	FB 296.342
64/519	FB 294.377
64/519	FB 298.344
64/521	FB 299.347
64/525	FB 299.347
64/535	FT 261.376
64/537	FB 296.342
64/539	FB 325.778
64/541	FR 299.378
64/559	FB 294.377
64/563	FB 325.778
64/573	FB 321.385
64/574	FB 321.385
64/581	XAC 316.593
64/583	FB 289.346
64/587	FBA 320.384
64/589	FBA 320.384
64/593	XAC 316.593
64/611	XAC 316.593
64/625	FB 294.377
64/633	FB 301.379
64/635	FB 323.386
64/641	FR 308.380
850/103	FB 325.778
850/97/139	FB 289.346
OSCO S	X 320.029
	FT 300.326
	FB 318.363

### **PICOT**

REFERENZ-NR.	ORDER-NR.
Picot	XAG 286.743

### **PRINCESS JAMAICA**

REFERENZ-NR.	ORDER-NR.
Princess Jamaica	XMF 298.712

### **RICOH**

REFERENZ-NR.	ORDER-NR.
038.104	XS 309.164
038.104	XS 310.427
061123	XAO-FAC 323.168
061248	XAO-FAC 323.169
61.123	XAO-FAC 321.151
61.202 A	XAO-FAC 334.172
61.243	XAO-FAC 322.152
61.247	XAO-FAC 316.149
61.248	XAO-FAC 320.150
61.248	XAO-FAC 313.146
61.248	XAO-FAC 314.147

# Marken- und Kaliberschlüssel

## Key to brands and calibres



### Fortsetzung / Continuation **RICOH**

REFERENZ-NR.	ORDER-NR.	
61.264	XAO-FAC	310.142
61.277 A	XAO-FAC	313.144
61.293 A	XAO-FAC	310.141
823 007	MT	290x290.1
824 003	MTR	180x230.1
826 001	MTR	280 x300.1
840 001	MT	230 x310.1
840 004	MTR	261x291.1
909	XAO-FAC	324.153
909-619909	XAO-FAC	324.170
CRYS 9	XAO-FAC	316.148
PW 206	XS	310.454
PW 719-30 GLAS 580508	XMF	300.865
PW 749-2	XMF	295.869
PW 891	MB	255x255.1
	XAO-FAC	299.166
DACHFLÄCHEN	XAO-FAC	302.185
	FE	306.339
	XAO-FAC	311.143
	XAO-FAC	313.145
	XAO-FAC	316.167
	FEA	322.360
	XAO-FAC	333.171
	XAO-FAC	335.173
	XS	352.188

### **ROAMER**

REFERENZ-NR.	ORDER-NR.	
X 7100	XS	218.411
X 7100	ST	218/206
X 7103	XS	260.100
X 7106	XS	293.103
X 7108	XS	310.412
X 7108	ST	310/295
X 7111	ST	322/310
X 7115	ST	295/283
X 7123	ST	292/280
X 7125	XS	310.104
X 7132	XS	293.103
X 7133	ST	310/295
X 7134	ST	310/295
X 7136	XS	310.104
X 7142	ST	291/280
X 7144	ST	260/248
X 7147	XS	310.413
X 7147	ST	310/296
X 7148	XS	310.403
X 7149	XS	195.414
X 7149	XS	195/414
X 7151	XS	195.414
X 7152	ST	215/204
X 7153	ST	215/204
X 7154	ST	215/204
X 7156	XS	310.104
X 7157	ST	218/207
X 7161	XS	195.415
X 7161	XS	195.415
X 7164	ST	316/305
X 7167	XS	306.402
X 7168	ST	322/310

### Fortsetzung / Continuation **ROAMER**

REFERENZ-NR.	ORDER-NR.	
X 7170	XS	316.404
X 7172	ST	291/280
X 7174	ST	322/310
X 7182	ST	306/295
X 7183	XS	305.199
X 7184	XS	178.198
X 7186	XS	306.401
X 7318	XS	356.405
	XS	316.130
	XS	316.131
	XS	340.132

### **ROLEX**

REFERENZ-NR.	ORDER-NR.	
CYCLOP 101	XS	215.428
CYCLOP 103	XS	248.458
CYCLOP 104	XS	254.129
CYCLOP 105	XS	256.129
CYCLOP 106	XS	275.467
CYCLOP 107	XS	280.101
CYCLOP 108	XS	292.155
CYCLOP 111	XS	293.134
CYCLOP 112	XS	295.464
CYCLOP 114, KAL.-NO. 3035, MODELL 16014	XS	306.154
CYCLOP 114, KAL.-NO. 1570, MODELL 1601	XS	304.465
CYCLOP 116	XS	302.450
CYCLOP 117	XS	295.157
CYCLOP 118	XS	306.133
CYCLOP 121	XS	212.460
CYCLOP 122	XS	180.471
CYCLOP 123	XS	294.463
CYCLOP 124	XS	332.461
CYCLOP 125	XS	303.462
CYCLOP 127	XS	303.430
CYCLOP 129	XS	215.429
CYCLOP 135	XS	307.457
CYCLOP 145	XS	297.459
TROPIC 3	XS	200.452
TROPIC 7	XS	253.455
TROPIC 11	XS	292.470
TROPIC 12	XS	293.156
TROPIC 13	XS	295.469
TROPIC 14	XS	293.102
TROPIC 19	XS	305.451
TROPIC 21	XS	306.449
TROPIC 26	X	276.035
TROPIC 30	XS	255.456
TROPIC 19	XS	303.472
25-206	XMR	216.204
25-246	XMR	257.201
25-286	XMR	297.203
25-295-1	XMR	306.200
67-193	XMR	199.202
25-206 C	XMR/L	216.302
25-246 C	XMR/L	257.303
25-286 C	XMR/L	297.304
25-295 C1	XMR/L	306.300
25-295 C2	XMR/L	306.301

# Marken- und Kaliberschlüssel

## Key to brands and calibres



### SECTOR

REFERENZ-NR.	ORDER-NR.	
Sector ADV 1500	XMS	278.901
Sector ADV 5000	XMS	258.904
Sector ADV 5500	XMS	268.905

### SEIKO

REFERENZ-NR.	ORDER-NR.	
170N 02 GN	XMF	170.856
180N10GN	XMF	180.852
180 W26 JKO1	XMF	180.703
185 T05	XAC	186.682
190 N 20 GN	XMF	190.854
190 W01 AL	XS	191.186
190 W35 HNOO	XMF	190.845
195 T03 ANSO	XAC	196.665
195 T03 AASO	XAC	196.665
195 W01 ALO	XS	196.136
195 W07 ALOO	XS	196.444
195 W07 SL	XS	196.444
200 N37 KNOO	XMF	200.851
200T04 ANSO	XAC	201.677
200 W01 AN	XS	201.406
200 W 49 LNOO	XMF	200.864
205 T25 ANSO	XAC	206.683
205 T25 ANG	XAG	206.696
210 T04 ANS	XAC	211.663
215 T13 AEGO	XAG	216.599
225 T01 AASO	XAC	226.662
265 N06 GNOO	XMF	265.874
266 W01 AN	XS	268.410
280 N 25 KNOO	XMF	280.872
285 N 05 KNOO	XMF	285.875
285 W12 GNOO	XMF	285.877
285 W61 LNOO	XPVIF	285.876
290 N06 GGN00	XMF	290.873
290 W08 GN	XMF	290.861
293 W01 ANOO	XS	295.445
295 N15 KNOO	XMF	295.871
295 W16 GA	XMF	295.849
295 W29 HNOO	XMF	295.859
295 W29 LN00	XMF	295.858
295 W35 HNOO	XMF	295.846
295 W41 LN00	XMF	295.850
295 W43 LN00	XMF	295.839
300 T03 ANG	XAG	301.532
300 T03 ANS	XAC	301.641
300 T04 ANG	XAG	301.616
300 T04 ANS	XAG	301.617
300 T07 ANG	XAG	301.639
300 T07 ANS	XAC	301.640
300 T10 ANG	XAG	301.618
300 T10 ANS	XAC	301.619
300 T12 ANG	XAG	301.540
300 T12 ANS	XAC	301.541
300T15 ANG	XAG	301.620
300 T15 ANS	XAC	301.621
300 T20 ANG	XAG	301.642
300 T20 ANS	XAC	301.598
300 T31 ALSO	XAC	301.684
300 T33 AASO	XAC	301.685
300 T40 ANAO	XAG	301.661

### Fortsetzung / Continuation SEIKO

REFERENZ-NR.	ORDER-NR.	
300 T44 ANG	XAG	301.645
300 T44 ANS	XAC	301.646
300 W76 GN	XMF	300.862
300 W96 GN	XMF	300.863
300 W08 GN	XMF	300.860
305 W20 GN00	MFO	305
308 W03 AN	XS	310.435
310 T04 ANG	XAG	311.582
310 T04 ANS	XAC	311.608
310 T08 ANG	XAG	311.643
310 T08 ANS	XAC	311.558
310 T10 ANG	XAG	311.531
310 T10 ANS	XAC	311.523
310 T11 ANG	XAG	311.623
310 T11 ANS	XAC	311.624
310 T12 ANS	XAC	311.569
310 T14 ANG	XAG	311.625
310 T14 ANS	XAC	311.626
310 T16 ANG	XAG	311.530
310 T16 ANS	XAC	311.569
310 T18 ANG	XAG	311.649
310 T18 ANS	XAC	311.650
310 T19 ANG	XAG	310.627
310 T19 ANS	XAC	310.583
310 T23 ANS	XAC	311.652
310 T25 ANG	XAG	311.628
310 T25 ANS	XAC	311.629
310 T48 ANG	XAG	311.647
310 T48 ANS	XAC	311.648
310 T49 ANG	XAG	311.651
310 T49 ANSO	XAC	311.652
310 T51 ACS	XAC-FAC	311.686
310 T57ANG	XAG	311.676
310 T57 ANSO	XAC	311.664
310 T57 AASO	XAC	311.664
310 W01 AN	XS	312.436
310 W04 AN	XS	312.408
310 W17 GN00	XMF	310.848
310 W17 LN00	XMF	310.848
310 W19 GN00	XMF	310.847
310 W21 GN00	XMF	310.857
310 W50 GN	XMF	310.853
310 W52 GN00	XMF	310.857
313 T01 ANG	XAG	314.542
313 T01 ANS	XAC	314.543
315 T04 ANG	XAG	316.630
315 T04 ANS	XAC	316.631
315 T08 ANS	XAC	316.524
315 W02 AN	XS	317.407
318 N02 AN	X	319.058
320 T01 ANG	XAG	321.644
320 T01 ANS	XAC	321.528
320 T02 ANG	XAG	321.632
320 T02 ANS	XAC	321.525
320 T04 ANG	XAG	321.637
320 T04 ANS	XAC	321.638
320 T15 ANG	XAG	321.633
320 T15 ANS	XAC	321.634
320 T21 ANG	XAG	321.635
320 T21 ANS	XAC	321.636
320 W03 AN	XS	322.409

# Marken- und Kaliberschlüssel

## Key to brands and calibres



Fortsetzung / Continuation **SEIKO**

REFERENZ-NR.	ORDER-NR.	
320 W05 AN	XS	322.422
320 W19 GN00	XMF	320.855
325 T02 ANG	XAG	326.533
325 T02 ANS	XAC	326.534
325 W04 AN	XS	327.125
325 W05 AN	XS	327.161
325 W06 AN	XS	327.160
327 W01 AN00	XS	329.437
327 W08 AN	XS	329.126
329 W01 AN00	XS	331.438
330 W16 GN	XMD	330.844
330 W18 GN	XMD	330.821
335 W01 AN	XS	337.127
338 N01 AN	X	338.052
340 N05 AN	X	344.059
340 T06 ANG	XAG	341.544
340 T06 ANS	XAC	341.545
340 W02 AN	XS	342.128
340 W06 AN00	XS	342.162
340 W14 GN	XMD	340.811
340 W18 GN	XY	340.354
341 W02 AN	XS	343.439
350 T02 ANG	XAG	351.536
350 T02 ANS	XAC	351.537
365 V06 GNSO	XMF	365.900
45120555	XS	322.114
BAO W16 AN	UT	239x294x309x329
BAO W49 LN00	MTR	219x284.1
BAO W58 AN	UT	253x293x309x319
BAO W91 LN00	MTR	189x269.1
BAO W95 LN00	MTR	188x273.1
ESO W09 AN00	FB	314.371
ES1 W14 GN00	MBS	253x288.1
ES1 W32 GN00	MTS	256x255.1
ES3 N25 AN00	RZR	229x159-7.5
ESG N69 JN00	MRS	195x180.1
ESJ N07 HN00	MBR	285x245.1
ESH N59 HN00	MRR	235x220.1
KOO W10 AN	FE	245.364
KOO W16 AN	UEB	308x259x348x307
KOO W 26 AC	FE	314.366
REO W02 AN	UR	297x231x308x299
REO W06 AN	UBT	230x295x310x328
REO W12 AC	URT	278x218x308x328
REO W21 AN00	UR	290x270x331x311
REO W24 AC	URB	192x147x225x209
RE1 W 81 LNO1	MRS	260x245.1
RE4 N 22 GN00	MR	245x200.1
RE6 N 73 LN00	MR	240x200.1
RE6 N97 LN00	MBR	270x220.1
SAO W02 AN	FB	296.387
SAO W04 AN	FB	214.302
SAO W 06 AN	FB	294.350
SAO W 08 AN	UB	192x192x216x216
SAO W16 AN	UB	275x255x300x300
SAO W 21 AN00	FB	321.365
SAO W 30 AN	FB	314.454
SAO W31 AN	UB	289x269x332x312
SAO W33 AN	UB	283x248x307x295
SAO W48 AN	UB	217x192x242x217
SAO W64 GN00	MBR	314x314.2

Fortsetzung / Continuation **SEIKO**

REFERENZ-NR.	ORDER-NR.	
SAO W82 GN	MBR	334x269.1
SA1 N 38 GN00	MBR	274x254.1
SA1 W00 GN00	MBR	313x274.1
SA1 W 06 GN00	MBR	329x264.1
SA1 W23 AN00	UB	204x194x230x220
SA1 W 50 GN00	MBR	308x263.1
SA1 W77 HN00	MBR	314x314.1
SA2 W14 GN00	MBR	288x268.1
SA2 W27 HN00	MBR	290x275.1
SA3 N00 GN00	MBR	200x175.1
SA3 N34 GN00	MBR	187x187.1
SA3 N40 GN00	MBR	244x244.1
SA3 N42 GN00	MBR	257x246.1
SA3 N50 GN	MBR	291x256.1
SA3 W44 GN00	MBR	275x255.1
SQO W02 AN	UR	275x275x300x300
	XS	355.124
190 P01 HN03	XMF	190.926
270 WAO HK01	XMF	270.700
275 W30 HK01 HL	XMF	275.701
310 W62 GN00 1209	XMF	310.925
315 W26 HK01	XMF	315.702
320 W42 GN00 1148	XMF	320.927
330 W26 GN00 HL	XMF	330.928
BAO P83 LN03	MTR	255x235.1
ESA W47 LNO1	MTR	265x255.1
SA3 W22 GN	MBR	220x200.1

### SWATCH

REFERENZ-NR.	ORDER-NR.	
Swatch Chrono	XAC	347.698
Swatch Irony Medium	XU	292.221

### TIME FORCE

REFERENZ-NR.	ORDER-NR.	
Time Force 5501	XMF	266.715
Time Force 5589	XMF	266.715

### TISSOT

REFERENZ-NR.	ORDER-NR.	
850	XAO	322.554
10283-3	XAG	316.548
10283-3	XAC	316.549
	XAC	316.522
	XAG	316.521

### WESTEND

REFERENZ-NR.	ORDER-NR.	
MODELL 64	X	269.047
MODELL 1974	X	279.048





**Kopierschleifmaschine  
KRONOGLAS**

**Copying milling machine  
KRONOGLASS**



**Nr. 16**  
Kronoglas-  
Maschine mit Getriebemotor  
zum Schleifen von Mineralgläsern

Die Kopierschleifmaschine KRONOGLASS ist lieferbar unter der Best.-Nr. 16 mit Motor zum halbautomatischen Betrieb. Die Maschine wurde konstruiert zum Schleifen von Mineralgläsern aller Formen, die zusätzlich einen sauberen Kantenbruch auf beiden Seiten erhalten. Auch die harten Kunststoffscheiben MINEPLAN YPL können auf der Maschine geschliffen werden. Vor der Anfertigung eines Formglases muss eine Schablone angefertigt werden. Dazu wird eine Gießharzausrüstung mit

der Maschine geliefert. Die Standardausrüstung besteht aus der Maschine mit Wassertank und Umlaufpumpe für die Kühlung, einer Gießharzpackung K1 und K2 zur Anfertigung von Schablonen, einer Flasche Emulsion K3 für das Kühlwasser, einem Korundstein K5, 4 Schlüsseln und 60 Mineralglasplatten MPL sortiert.

**No. 16**  
Kronoglas-  
maschine with motor  
for grinding mineral glasses

The copying milling machine KRONOGLASS is available under the order No. 16 with motor for halfautomatic grinding. The machine is constructed for grinding mineral glasses of all shapes, which additionally get a bevel on both sides. The hard unbreakable watch glass plates MINEPLAN YPL can also be grinded on this machine. Before producing a fancy glass, a template has to be manufactured. A resin equipment is also delivered together with this machine.

The standard equipment contains the machine with tank and water circulation pump for the cooling, resin K1 and hardening liquid K2 for the manufacture of templates. A corundum stone K5, 4 keys and 60 assorted mineral glass plates MPL.

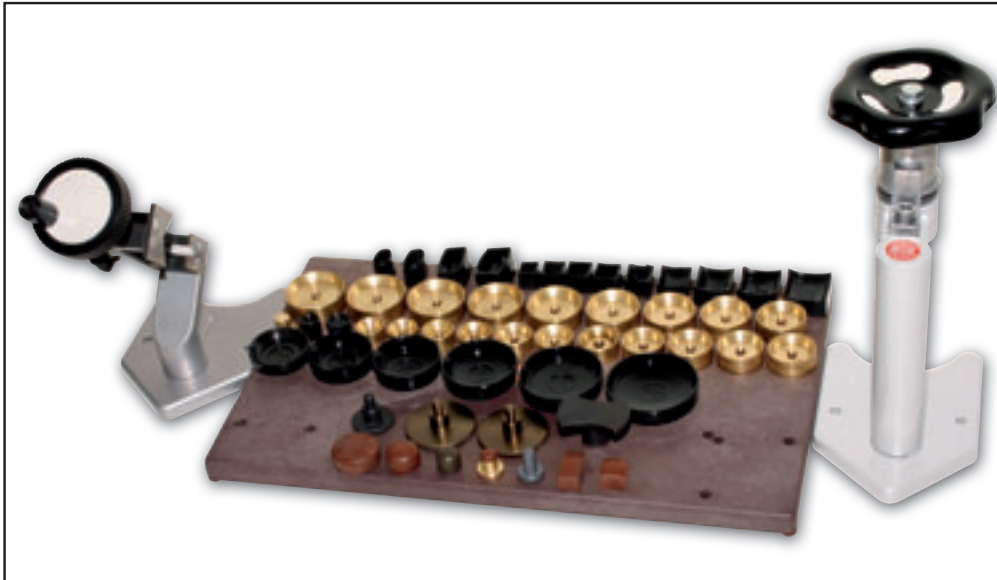

**No. 81**  
Einsetzvorrichtung  
Universal komplett

Universal Fitting tool  
complete

**No. 885**  
Satz konvexer  
Gummidruckstücke  
set of konvex rubber  
chucks

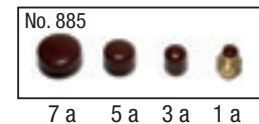

**No. 883** Satz konkaver Metalldruckstücke  
set of concave metal chucks



35 S 34 S 33 S 32 S 31 S 30 S 29 S 28 S 27 S  
16 S 17 S 18 S 19 S 20 S 21 S 22 S 23 S 24 S 25 S 26 S

zusätzlich sind folgende Sondergrößen lieferbar:  
additionally the following special sizes are available:  
36 S, 37 S, 38 S, 39 S, 40 S, 41 S, 42 S, 43 S, 45 S

**No. 886**  
Druckstückpaar für  
Kleinstgläser  
pair of chucks for  
smallest glasses



**No. 884** Satz konkaver Kunststoffdruckstücke  
set of concave plastic chucks



12 14 35 36 38 42 46 50

**No. 887**  
Aufnahmeteller  
supports



**No. 283** Satz konkaver Form-Kunststoffdruckstücke  
set of concave shaped plastic chucks



E1 E2 T1 T2 RX1 RZ1 RX2 RZ2 RX3 RX4 RZ4 RX5 RX6

**No. 888**  
Universal-Teller  
universal case support



# Werkzeuge – Tools



## Einsetzvorrichtung für Rundglas-Sonderformen Fitting tool for special round glasses

No. 98



Inhalt / contents

40 x					
+ F 4	F 3	F 2	F 1		
46 x					
38 x	S 3	S 3	S 4	S 4	
32 x	33 x	34 x	35 x	36 x	
26 x	27 x	28 x	29 x	30 x	31 x
25 x	24 x	23 x	22 x	21 x	19 x

Kasten / Box No. 982  
ohne Inhalt / without contents

### Sonderdruckstücke / special chucks

#### Ergänzungssätze, supplementary sets:

Satz Kunststoffdruckstücke für Mineralgläser  
Set of plastic chucks for mineral glasses



1F

OF

OOF

#### No. 55, 65, 70

Druckstücke aus Kunststoff  
chucks of plastic material



No. 55, 65 + 75

#### No. 48 + 51

Druckstücke aus Kunststoff  
chucks of plastic material



No. 48 + 51



S 1 - S 4

S 1	kleiner Aufnahmeteller supports, small	- Durchmesser - diameter	23 mm	- Zapfenlänge - length of pivot	8 mm
S 2	Aufnahmeteller supports	- Durchmesser - diameter	38 mm	- Zapfenlänge - length of pivot	8 mm
S 3	Aufnahmeteller supports	- Durchmesser - diameter	38 mm	- Zapfenlänge - length of pivot	3,5 mm
S 4	Aufnahmeteller supports	- Durchmesser - diameter	38 mm	- Zapfenlänge - length of pivot	10 mm

# Werkzeuge – Tools



## Einsetzvorrichtung mit Quickbend + Druckstücksätzen 383 und 384 Fitting tool with Quickbend + set of chucks No. 383 and 384

No. 38



Inhalt / contents

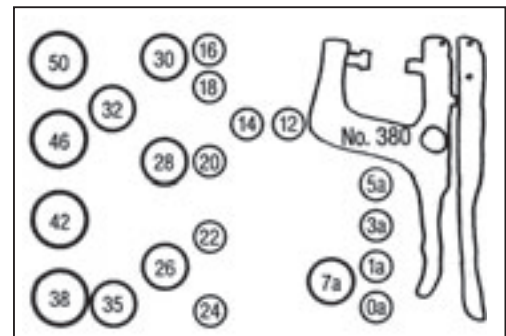

Kasten / Box No. 382  
ohne Inhalt / without contents

### Ergänzungssätze, supplementary sets:

No. 283 Satz konkaver Form-Kunststoffdruckstücke  
set of concave shaped plastic chucks

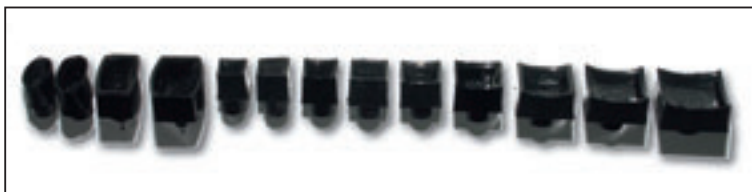

E 1 E 2 T 1 T 2 RX 1 RZ 1 RX 2 RZ 2 RX 3 RZ 3 RX 4 RX 5 RX 6

No. 388 Satz runder konkaver Kunststoffdruckstücke  
set of round, concave plastic chucks



31	Planes
	Druckst.
29	19
33	27
34	21
	25
	23

No. 385 Satz runder konvexer Gummidruckstücke  
set of convex rubber chucks



RA 3  
RA 1

## QUICKPRESS



### Druckstücksatz für Einsprenggläser Set of chucks for tension fitting

#### No. 800

Setzwerkzeug höchster Präzision mit Doppelgewinde für schnelles, aber doch präzises Arbeiten, selbstzentrierend.

Bei Verwendung des Gewindetellersatzes Nr. 887 passen alle auf dem Markt befindlichen Fabrikate von Metalldruckstücken (Gewinde M6) zu der QUICKPRESS.

Fitting tool of highest precision with double screw thread for fast but precise working with self-alignment.

Using the set of supports no. 887 all brands of metal chucks available on the market fit with QUICKPRESS (thread M6).

#### No. 804

Bestehend aus Grundbrett, 25 Kunststoff-Druckstücken rund und 15 Kunststoff-Druckstücken form, 2 Metall- und 3 Gummi-Druckstücken für Einsprenggläser. (Grundbrett einzeln: Best.-Nr. 806, einzelne Druckstücke)

Consisting of penel, 25 round plastic chucks and 15 fancy plastic chucks, 2 metal and 3 rubber chucks for snap-in glasses. (penal separately: order no. 806, separate chucks)



## Basis - Fuß



#### No. 802

Für die beiden Grundbretter mit Druckstücken in den Zusammenstellungen 803 und 804.

For the two penals with chucks in the arrangements 803 and 804.

## Druckstücksatz für Mineral- und armierte Gläser Set of chucks for mineral- and armed glasses



#### No. 803

Bestehend aus Grundbrett, 3 Gewindetellern, 20 Messingdruckstücken von 16-35 mm  $\emptyset$ , 1/2 mm-weise gestuft und 3 flachen Kunststoff-Druckstücken für Mineralgläser (Grundbrett einzeln: Best.-Nr. 805, einzelne Druckstücke)

Consisting of penel, 3 supports, 20 metal chucks from 16 to 35 mm diameter, graded all 0,5 mm, and 3 flat plastic chucks for mineral glasses (penal separately: order no. 805, separate chucks)

## Quickbend



#### Nr. 380

Die praktische Zange für das Setzen von Einsprenggläsern, passend für alle Kunststoff- und Gummidruckstücke mit 10 mm Zapfen. Einfache Druckregulierung durch Rändelschraube und Gegenmutter.

The practical pliers for fitting of snap-in glasses, appropriate for all plastic and rubber chucks with 10 mm bases.

Easy pressure regulation by means of head screw and lock-nut.

## Quickex



#### No. 801

Der ergonomisch richtige Glasabzieher für alle allzu feststehenden Kunststoffuhrgläser.

The correct glass removing appliance for easy handling for all too tight fitted plastic watch glasses.

## Aufbauschränke

STERNKREUZ-Aufbauschränke schaffen Ordnung im Lager. STERNKREUZ-Aufbauschränke sind vorwiegend zur Aufbewahrung von Uhrgläsern vorgesehen und in ihren Abmessungen auf diese abgestimmt. Sie eignen sich aber auch für alle vorkommenden Uhrenfurnituren durch ihre vielfältigen Einteilungsmöglichkeiten.

## Storage cabinet

STERNKREUZ-storage cabinets facilitate the location of your stock. They are mainly used for the storage of watch glasses, and their dimensions are suitable for it. However, they can also be used for the storage of other spare parts because of their various possibilities of division



Lieferbar sind folgende Schränke:

- Nr. 112 Sockel
- Nr. 114 Deckel
- Nr. 100 Aufbauschränk, ohne Inhalt, mit Schlitten für die Facheinteilung Formgläser und/oder Rundgläser
- Nr. 130 Aufbauschränk für Rundgläser mit 5 Holztrennwänden und 50 Einsteckbrettchen
- Nr. 120 Aufbauschränk für Formgläser mit 7 Holztrennwänden und 70 Einsteckbrettchen
- Nr. 125 Aufbauschränk kombiniert für Rund- und Formgläser mit 6 Holztrennwänden und je 30 Einsteckbrettchen

Einzelteile:

- Nr. 123 Einsteckbrettchen für Formgläser
- Nr. 133 Einsteckbrettchen für Rundgläser
- Nr. 135 Holztrennwände, einzeln

The following cabinets are available:

- No. 112 Stand
- No. 114 Cover
- No. 100 Storage cabinet, empty, with slots for shaped and/or round watch glasses
- No. 130 Storage cabinet for round watch glasses, with 5 wooden separations and 50 trays
- No. 120 Storage cabinet for shaped glasses, with 7 wooden separations and 70 trays
- No. 125 Storage cabinet, combination for round and shaped watch glasses, with 6 separations and 30 trays for each type

Singel parts for storage cabinet:

- No. 123 Trays for shaped glasses
- No. 133 Trays for round glasses
- No. 135 Wooden separations for watchglass-cabinet

## STERNKREUZ Uhrmacherlupen sind besonders leicht und elastisch STERNKREUZ Watchmakers' Eyepieces are particularly light and elastic

### No. 311 + 312

Uhrmacherlupen, ohne und mit  
farbigem Kennrand  
watchmakers eyepieces,  
without and with colour coded edges

### No. 313

Uhrmacherlupen,  
Aplanatische Lupen  
watchmakers eyepieces,  
aplanetic lenses

### No. 314

Steinlupe  
lense for stones  
magnification



lieferbar in der normalen Ausführung:

Nr. 311-1	Stärke 1	Vergrößerung	10 -fach	(mit Blende)
Nr. 311-1½	Stärke 1½	Vergrößerung	6,7-fach	(mit Blende)
Nr. 311-2	Stärke 2	Vergrößerung	5 -fach	
Nr. 311-2/2	Stärke 2½	Vergrößerung	4 -fach	
Nr. 311-3	Stärke 3	Vergrößerung	3,3-fach	
Nr. 311-3½	Stärke 3½	Vergrößerung	2,8-fach	
Nr. 311-4	Stärke 4	Vergrößerung	2,5-fach	

available in standard models:

Nr. 311-1	Luminosity 1	Magnification	10 -x	(with diaphragm)
Nr. 311-1½	Luminosity 1½	Magnification	6,7-x	(with diaphragm)
Nr. 311-2	Luminosity 2	Magnification	5 -x	
Nr. 311-2½	Luminosity 2½	Magnification	4 -x	
Nr. 311-3	Luminosity 3	Magnification	3,3-x	
Nr. 311-3½	Luminosity 3½	Magnification	2,8-x	
Nr. 311-4	Luminosity 4	Magnification	2,5-x	

lieferbar mit farbigem Kennrand zwecks Unterscheidung  
der verschiedenen Vergrößerungen und Stärken

Nr. 312-1	Stärke 1	Vergrößerung	10 -fach	(mit Blende)	Rand rot
Nr. 312-1½	Stärke 1½	Vergrößerung	6,7-fach	(mit Blende)	Rand rot/weiß
Nr. 312-2	Stärke 2	Vergrößerung	5 -fach		Rand blau
Nr. 312-2½	Stärke 2½	Vergrößerung	4 -fach		Rand blau/weiß
Nr. 312-3	Stärke 3	Vergrößerung	3,3-fach		Rand gelb
Nr. 312-3½	Stärke 3½	Vergrößerung	2,8-fach		Rand gelb/weiß
Nr. 312-4	Stärke 4	Vergrößerung	2,5-fach		Rand weiß

lieferbar mit farbigem Kennrand zwecks Unterscheidung  
der verschiedenen Vergrößerungen und Stärken

Nr. 312-1	Luminosity 1	Magnification	10 -x	(with diaphragm)	red border
Nr. 312-1½	Luminosity 1½	Magnification	6,7-x	(with diaphragm)	red/white border
Nr. 312-2	Luminosity 2	Magnification	5 -x		blue border
Nr. 312-2½	Luminosity 2½	Magnification	4 -x		blue/white border
Nr. 312-3	Luminosity 3	Magnification	3,3-x		yellow border
Nr. 312-3½	Luminosity 3½	Magnification	2,8-x		yellow/white border
Nr. 312-4	Luminosity 4	Magnification	2,5-x		white border

### Sonderausführungen

Nr. 313-1	Aplanatische Lupen, Vergrößerung	10-fach
Nr. 313-½	Aplanatische Lupen, Vergrößerung	6-fach
Nr. 314-1	Steinlupen, Vergrößerung	10-fach

### Special models

Nr. 313-1	Aplanatic lenses, Magnification	10-x
Nr. 313-½	Aplanatic lenses, Magnification	6-x
Nr. 314-1	Lens for fine stones, Magnification	10-x

# Werkzeuge – Tools



**No. 276**  
Polierscheibe, weich  
buffering wheel, soft



**No. 275**  
Polierscheibe, hart  
buffering wheel, coarse



**No. 250**  
Uhrglasfeile  
file for glass rim

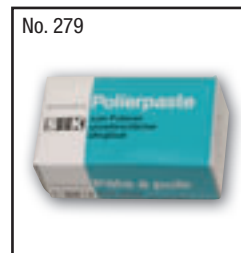

**No. 279**  
Polierpaste  
buffering paste

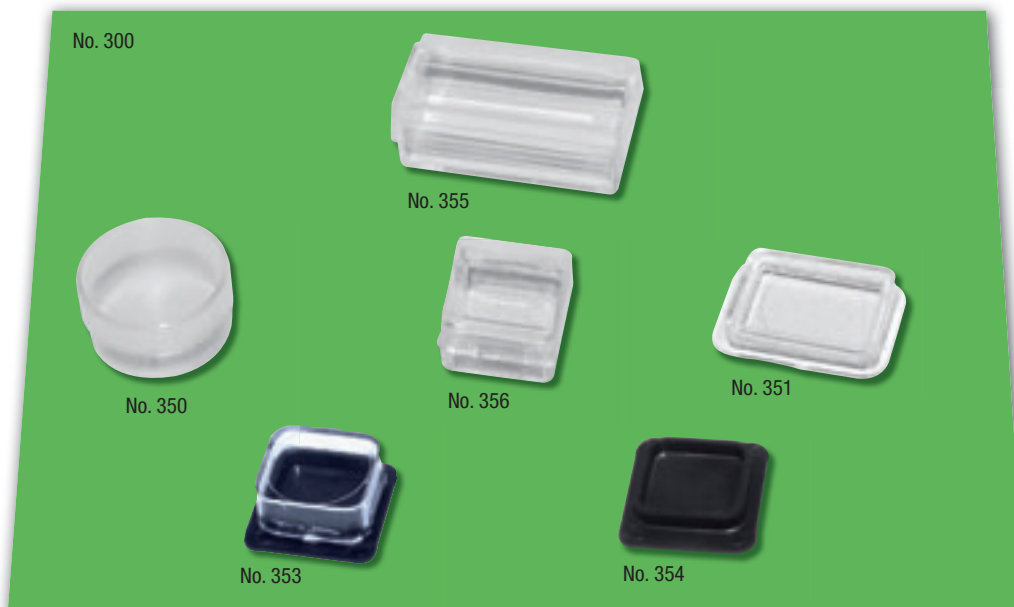

**No. 300**  
Arbeitsplatte  
300x240 mm  
workboard

No.	Höhe / height
<b>350</b>	24 mm
<b>351</b>	35,5x24,0 mm
<b>353</b>	24,3x24,0 mm
<b>357</b>	24,3x24,0 x 4,4mm Boden

No.	Höhe / height
<b>354</b>	24,3x24,0 mm
<b>355</b>	45,0x22,5 mm
<b>356</b>	22,5x22,5 mm
<b>358</b>	21,0x19,0 x 7,7 mm Deckel
<b>359</b>	21,0x19,0 x 5,3 mm Deckel



## STERNKREUZ liefert Ihnen Kleber zum Einsetzen von Uhrgläsern

## For the fitting of watch glasses STERNKREUZ supply you with adhesive

### Best.-Nr. 224

STERNKREUZ-MINECOL, den idealen und lange lagerfähigen **Klebstoff für Mineralglaser**, der unter ultraviolettem Licht aushärtet.

Hierzu werden getrennt geliefert:

Best.-Nr. 225 Kanüle einzeln

Best.-Nr. 226 Mini-Kanüle besonders dünn und kurz

Best.-Nr. 227 Ultraviolett-Birne mit Normalfassung E 27



Nr. 224

### Order No. 224

STERNKREUZ-MINECOL, the ideal **adhesive for mineral glasses**, which can be stocked a long time and which hardens by contact with UV-rays.

The following accessoires will be supplied separately:

order No. 225 hypodermic needle, separately:

order No. 226 Mini hypodermic needle, especially thin and short

order No. 227 ultra-violet lamp with normal setting E 27



Nr. 225



Nr. 226



### Best.-Nr. 229

STERNKREUZ-GS-PLASTICOL, den **Spezial-Klebstoff zum Verbinden von Kunststoffuhrgläsern mit dem Metallgehäuse**. Bei diesem Klebstoff wird jede Tube mit fest eingebauter Kanüle geliefert.

### Order No. 229

STERNKREUZ-GS-PLASTICOL, the **special adhesive for connecting unbreakable watch glasses with the metal case**. This adhesive is supplied with installed hypodermic needle.

